

RADIO'S *Complete* MAGAZINE

RADIO & TELEVISION

NEWEST TELEVISION ANTENNA

See Page 269



FREE! RADIO SETS FOR YOUR LETTERS!
See Page 261

25¢
CANADA 30¢

HUGO GERNSBACK
EDITOR

AMATEUR & EXPERIMENTAL RADIO

SEPT.

CONSTRUCTIVE RADIO ARTICLES

1941



THE LIGHT THAT MUST NOT GO OUT!

FROM hour to hour, on wavelengths from far and near, Americans owning 50,000,000 radio receiving sets hear the news of war overseas. The broadcasts tell of raiders in foreign skies; they tell of terrific explosions and flames seen more than 100 miles away. Commentators tell of blackouts—15 hours of blackness at a stretch in London . . . In the United States, radio is the voice of national defense.

A light in the darkness that enshrouds the world is the truth of an uncensored radio . . . broadcasts from American aerial towers that stand as sentinels of freedom. The light of truth in American radio is not shaded or hooded . . . it is the glow of hope for free men everywhere. For many months now, the National Broadcast-

ing Company, through modern improvements in equipment and increased power in short-wave transmitters, has helped to make certain that the slit of light on radios in homes throughout the Americas will burn as one great beacon of freedom . . . for these broadcasts spread into the far corners of the darkened world.

By short waves, NBC is flashing

the truth, as it is received from its American observers in foreign lands, and from the press associations.

Cordial, two-way relations have been established through exchange of programs between North and South America . . . and NBC is happy that it has the opportunity and facilities to contribute to the cultivation of all-American friendships . . . every one of NBC's programs are

sent free of charge to Latin America, that they may be rebroadcast for the pleasure of our southern neighbors.

That there shall be no blackout in the light of American radio . . . that there be no blindfolding of listeners, no hooding or curtaining of the truth, is the aim of NBC . . . Radio's light of truth must never fail.



NBC

National Broadcasting Company

A Service of the

**RADIO CORPORATION
OF AMERICA**

Radio City, New York



Is this what you want to know?

I will answer these questions for you—show you how to become a SUCCESS IN RADIO

Knowing the answers to questions like these, and others which arise while doing work as a Radio Technician or Operator has spelled the difference between success and failure for many men. Such knowledge represents the difference between a skilled, well-paid Radio Technician or Operator and the too-common "Radio screw-driver-mechanic." If you do not know the answers; If you want to make more money in Radio, I will teach them to you at home nights in your spare time.—I will train you to be a Radio Technician or Operator whether you are already in Radio, or are just a beginner without knowledge or experience.

Why Many Radio Technicians I Train Make \$30, \$40, \$50 a Week

N.R.I. trained Radio Technicians hold good jobs in practically every branch of Radio, selling, servicing, installing, repairing home and auto Radio sets. N.R.I. trained Radio Operators have good jobs in Broadcasting, Commercial, Aviation, Police, Ship, Radio Stations. Many operate their own part or full-time Radio businesses, fixing, selling Radio sets. Others make good money in Public Address work and other branches of the Radio industry. My Course is thorough and practical. I give you basic training in Radio Theory and Engineering Practice which enables you to understand the design and operation of practically

every type of Radio apparatus. I give you the answers to all usual Radio questions plus the knowledge to think out practically every type of Radio problem. You have knowledge to help you become successful, not just mechanical training to fix a few things and make a few simple adjustments. That's why many men who were in Radio before taking my Course report making more money, winning bigger success. I train you, too, for Television, a promising field of future opportunity.

Beginners Quickly Learn to Earn \$5 to \$10 a Week Extra In Spare Time

Nearly every neighborhood offers opportunities for good part-time Radio Technician to make extra money fixing Radio sets. I give you special training to show you how to start cashing in on these opportunities early. You get Radio parts and instructions for building test equipment, for conducting experiments that give you valuable practical experience. My 50-50 method of training—half with Radio Parts I send you, half studying my Lesson Tests—makes learning Radio at home interesting, fascinating, practical.



You Get This Professional Servicing Instrument

as part of my Course to help you make more money, do better Radio work. For full details mail the Coupon.

MAIL THE COUPON NOW—get my Sample Lesson and 64-page Book "Rich Rewards in Radio" at once. They're free. See what Radio offers you as a skilled Radio Technician or Operator. Learn how practical my Course really is. Read letters from more than 100 men I have trained, telling what they are doing and earning. Mail the Coupon NOW in an envelope or paste it on a penny postal.

J. E. SMITH, President, Dept. 1JB3
National Radio Institute,
Washington, D. C.

1. How to read diagrams and analyze them.
2. How to use test instruments.
3. How to get started in professional Radio.
4. Hints on how to run your service business profitably.
5. How to install P.A. equipment.
6. How to install inter-communicating systems.
7. How to figure charges.
8. What servicing instruments to buy.
9. How to locate parts in a chassis with and without service data.
10. How to know the cause of receiver trouble from observed effects.
11. How to make tests which isolate the defective stage and parts.
12. How to check for defects in a chassis.
13. How to align receivers without reference to service manuals.
14. How to appraise receiver performance from a circuit diagram.
15. How to plan your service bench and shop.
16. How to develop a time-saving servicing technique.
17. Short cuts in servicing midget universal receivers.
18. How modern electronic television receivers operate.
19. How to install and service television receivers.
20. How to practice servicing Radios to gain needed experience.
21. Practical demonstrations that show how basic Radio circuits operate.

Sample Lesson FREE

I want to prove our Course gives practical, money-making information; that it is easy to understand—what you need to master Radio. My sample lesson text, "Radio Receiver Troubles—Their Cause and Remedy," covers a long list of Radio receiver troubles in A.C., D.C., battery, universal, auto, T.R.F., superheterodyne, all-wave, and other types of sets. And a cross reference system gives you the probable cause and a quick way to locate and remedy these set troubles. A special section is devoted to receiver check-up, alignment, balancing, neutralizing, testing. Get this lesson Free by mailing the coupon.



GOOD FOR BOTH 64 PAGE BOOK SAMPLE LESSON FREE

J. E. Smith, President, Dept. 1JB3
National Radio Institute, Washington, D. C.

Mail me FREE, without obligation, Sample Lesson and 64-page book "Rich Rewards in Radio," which tells about Radio's opportunities and explains your 50-50 method of training men at home. (No salesman will call. Write plainly.)

Age

Name

Address

City State 14X-1

Extra Pay in Army, Navy, Too

Every man likely to go into military service, every soldier, sailor, marine, should mail the Coupon Now! Learning Radio helps men set extra rank, extra prestige, more interesting duty at pay up to 6 times base pay. Also prepares for good Radio jobs after service ends. IT'S SMART TO TRAIN FOR RADIO NOW!

RADIO & TELEVISION

The Popular Radio Magazine

September — 1941
Vol. XII No. 5

HUGO GERNSBACK, Editor
H. WINFIELD SECOR, Manag. Editor
ROBERT EICHBERG, Television and
Digest Editor

In October Issue

A Simple "Home Recorder" for Radio and Studio Pick-up
Grid Modulating the "Compact-Kilowatt" Transmitter—Larry LeKashman, W2IOP
Ultra-High Frequency Tuner—George F. Baptiste
Simple Antenna Measurements—Howard H. Arnold
Ultra-Short Wave Low-Power Oscillator—A. Binneweg, Jr.
"End-Fed" Zepp for Receiving—R. H. Newkirk, W9BRD

In This Issue

GENERAL FEATURES

Readers' Editorials—What Amateurs Can Do 261

MARCH OF RADIO

Television Tries New Technique ... 262
Radio Increases Plane Safety ... 263
Guarding the Ether 264
Facsimile Replaces Photostat ... 264
Static Test? 265
Building a "Bug" Key 266
Four Tube Vibrator Set 267
Cover Feature—"Newest Television Antenna" 269
Radiophotos From Moscow! 270

RADIO CONSTRUCTION

Battery Short-Wave Receiver — Joseph Hiatt 272
"Metal Tube" Two 274
Dual-Purpose Public Address System—Andrew Tait 275

Certified Circuits



When you see this seal on a set it is a guarantee that it has been tested and certified in our laboratories, as well as privately in different parts of the country. Only constructional—experimental sets are certified.

You need not hesitate to spend money on parts because the set and circuit are bona fide.

This is the only magazine that renders such a service.

Your First Short Wave Set—Wm. J. Vette 278

Pull-Swing FM Transmitter 288

AMATEUR RADIO

"Metal Tube" Two 274
Your First Short-Wave Receiver ... 278
Plaque Award for Best Ham Station Photo 281
Fixed Condensers in Radio Transmitters 282
Two Little "Gem" Transmitters—J. A. Szabo, W9JOI 285
Hams Report Motorboat Races ... 286
Pull-Swing FM Transmitter — R. Muniz, E.E. Donald & Warren Oestreicher 288

NEW FEATURES

Applied Radio—Something New in Aerials, by "Electronics Testing Lab's" Staff 292
"Frequency Modulation" Receivers—F. L. Sprayberry 294
Radio Beginner—Old Reliable One-Tube Receiver—L. M. Dezettel, W9SFW 298
Radio Hook-ups 300
Electrical Experiments 306
Radio Patents 308

TELEVISION NEWS

New Television Technique 262
Du Mont Vision Station 268
CBS Teaches Dancing by Television 268
Newest Television Aerial (Cover Feature) 269
Radiophotos From Moscow! 270
Television Patents 308

MISCELLANEOUS

Readers' Letters 259
Can YOU Answer These Radio Questions? 267
Honor Plaque Award for Best Ham Station 281
Something New in "All-Wave" Aerials 292
"Frequency Modulation" Receivers—F. L. Sprayberry 294
Radio Hook-Ups 300
Question Box—Edited by Herman Yellin, W2AJL 302
Radio Kinks 304
A Slide Wire Bridge—John L. Belfi 306
Radio Patents 308
Simple Test Circuit 310
New Radio Apparatus 312
Book Review 318

Cover Photo "Newest Television Aerial"—Courtesy General Electric Co.—See Page 269

RADIO & TELEVISION—Published monthly on the tenth of the month. Entered as second-class matter Feb. 15, 1938, at the post office at Springfield, Mass., under the act of March 3, 1879. Trademarks and copyrights by permission of H. Gernsback. Text and illustrations are copyright and may not be reproduced without permission. Subscription price \$2.50 a year in the United States (in foreign countries, 75c additional per year to cover postage; Canada 50c additional). Make all subscription checks payable to Popular Book Corporation. All communications about subscriptions should be addressed to: Director of Circulation, 20 Vesey St., New York, N. Y.

Published by Popular Book Corporation, Publication Office—26 Worthington St., Springfield, Mass. Editorial and Executive Offices—20 Vesey St., New York, N. Y. HUGO GERNSBACK, President; EMIL GROSSMAN, Director of Advertising. European Agents: Atlas Publishing and Distributing Co., Ltd., 18 Bride Lane, Fleet St., London, England; Brentano's—London and Paris. Australian Agents: McGill's Agency, 179 Elizabeth St., Melbourne.

Copyright 1941 by H. Gernsback

What Do YOU Think?

WHAT DO YOU THINK?

Editor:

I have been reading your FB magazine for six months, and I find it to be the best radio magazine published.

While reading this column in the June issue, I read Albert Braman's letter on having the F.C.C. let the SWL's have the 1 1/4 meter band. I think this is a very fine plan and we SWL's should do something about it. Let's get together and get this worked out. The SWL could become a licensed Ham a lot more efficiently if he learned by actually operating equipment. I think this should meet with everyone's approval to have more efficient operators for the defense program. Come on, you SWL's—let's do something about this.

Since the beginning of the war many countries have stopped amateur radio activities. The U. S. and its possessions still allow amateurs to operate. I think it would be very fine if "R. & T." gave a VAUSP certificate to SWL's who verify all U. S. possessions.

I would be glad to hear from any SWL anywhere.

VICTOR FELTON,
1119 S. Michigan Ave.,
Williston, Ohio.

ARE HAMS "COPY-CATS"?

Editor:

And so the endless feud between the "SWL" and the "HAM" continues. If there is room for my two and a half cents, I'd like to stick mine in.

First I'll introduce myself. I'm an active Ham holding a Class A and all the commercial operator's tickets. Thus, I've met all types of Hams, Commercial Operators and SWL's. Therefore I say that there is but little difference between the SWL and the Ham. The SWL builds receivers—the Ham builds rigs. I assure you, good receivers require more ability than "rigs" do. The Ham has already memorized the license manual, the SWL is going to memorize it. I have frequently found that the SWL has a more scientifically curious mind than the Ham, for a good reason: the Ham picks up a manual or magazine and chooses a diagram that looks plausible. He then buys the parts, punches holes in the chassis, (often) sloppily wires the rig, throws the switch and prays it will work. He should have no bugs in the rig because the designer got the original bugs out of it, yet his infernal foolness produces some. The SWL, being experimental, tries his own—the hard way. Many Hams are nothing more than a lot of "copy-cats." I'm a Ham, I know, Hi!

LEON A. WORTMAN,
482 Decatur St.,
Brooklyn, N. Y.

SWL'S ON 1 1/4 METERS

Editor:

Recently I bought my first copy of RADIO & TELEVISION and I liked it very much. The article Albert Braman had about SWL's going on 1 1/4 meters caught my attention. I have a few more suggestions to make. Why not let the amateurs operate

on 1 1/4 during certain hours and the SWL's on certain hours. In case of emergency, this could be changed so that anyone could operate at any time. The SWL's license could be similar to that of the present Ham's, but the requirements wouldn't have to be as stiff. Perhaps the main requirement would be knowing how to run the transmitter and a knowledge of amateur laws. This would help a lot of us SWL's obtain a regular license, and I think it would cut down on the number of boys going on the air without a license. It is worth trying and I hope it goes through. I would like to hear from more SWL's concerning this.

(SWL) TOMMY BULL,
Box 162.

Annandale, Minnesota.

THE INDISPENSABLE SPONSOR!

Editor,

I've been hearing a good many criticisms lately regarding the "Commercials" on our American radio programs: "Why do they have to take so much time for radio commercials?" "Why do they spoil such a splendid musical program with those blankety-blank plugs for products?" "If they'd eliminate all that commercial drivel from the radio we could enjoy the programs!"

Frankly, I'm fed up with this criticism. Oh, I'll admit I'd like to eliminate some of it myself—and if any of the Program Sponsors are "listenin' in," I'll be glad to pass on this tip: CUT your commercial announcements to the bone; and DON'T stick them in the MIDDLE of the program; I believe you will find the American audience appreciative and responsive.

But I wonder how many people stop to realize that the grand radio programs we hear week in and week out—the splendid bands and orchestras, the entertaining dramas and serials, the up-to-the-minute news commentators, the interesting quiz programs, etc.—are made possible BECAUSE THEY ARE SPONSORED! I've listened to a lot of short-wave programs from other countries, and I'm frank to confess that I still prefer our good old American sponsor "plugs" to the hemming and having, the "pause that does anything but refresh," the interminable wait between programs, and even between numbers, that seems to characterize many such programs from other nations.

Then, too, I much prefer the comparative freedom of our radio stations here in America to the Government-owned and -controlled wavelengths of Europe! Thank God for this great American principle in radio; "long may it air-wave" o'er "the land of the free and the home of the brave!"

From the day when I made my first one-tube battery set—and proudly picked up our local radio station three blocks away!—to the marvels of modern radio engineering, I've been thankful for the increasingly fine programs that have come forth from my radio loud-speakers; and that thankfulness extends to the SPONSORS who have made them possible.

REV. WILLIS J. LOAR,
Minister,
Liberty Park Baptist Church,
1411 E. 14th St.,
Spokane, Wash.

SPRAYBERRY TRAINS YOU for GOOD PAY! STEADY WORK! ADVANCEMENT! in RADIO and TELEVISION



DON'T WAIT! START NOW!

You Can Make Money Almost At Once! You'll be quickly shown how to get and do neighborhood Radio Service Jobs... for practice and profits. You easily learn Television, Frequency Modulation, Signal Tracing, Mobile Radio (Auto-Tank), Aviation Radio, Electronics, Facsimile Radio, Radio Set Repair and Installation Work. I'll Prepare You Quickly In Spare Time

At Home Or At Camp SPRAYBERRY Training does not interfere with your present work. You will receive personal coaching service all the way. You'll be fitted to hold down a good paying job in Radio or to have a Radio business of your own.

You Get Professional Test Equipment Plus Experimental Outfits includes 148 RADIO PARTS (to build complete Radio Receiver), RADIO TOOLS and a TESTER-ANALYZER. MY EXPERIMENTAL OUTFITS enable you to conduct actual experiments with your own hands.

NO EXPERIENCE NEEDED It makes no difference what your education has been. I can fit you to become a real RADIO TECHNICIAN. Your success is my full responsibility.

THE SPRAYBERRY COURSE IS SOLD UNDER MONEY-BACK AGREEMENT

RUSH COUPON for BIG FREE BOOK

SPRAYBERRY ACADEMY OF RADIO
F. L. Sprayberry, President
445 J University Place, N. W.
Washington, D. C.

Please request FREE copy of "HOW TO MAKE MONEY IN RADIO."

Name..... Age.....
Address.....
City..... State.....
(Mail in coupon or paste coupon on penny postcard)

LEARN RADIO TELEVISION

600 LICENSED graduates placed in past 7 years in shipping, broadcasting, aviation, police, etc.; we also teach radio servicing and repairing; new beginners' class forming Sept. 8th; 60-page catalog free; oldest, largest and best equipped.

MASS. RADIO SCHOOL
18 BOYLSTON ST., BOSTON, MASS., Est. 1899

RADIO-TELEVISION

Oldest, largest Radio-Television school in West trains you for good pay job. Complete instruction including Radio Construction and Service, Broadcast Operating, Sound, Talking Pictures, Television, Public Address, etc. Flexible plan to meet specific needs of those with or without jobs. Transportation allowed to L.A. Earn room and board while learning. Request Free Catalog.

NATIONAL SCHOOLS, Dept. 9-RT
Los Angeles

RADIO COURSES

Start September

- RADIO OPERATING—BROADCASTING
- RADIO SERVICING—a practical course
- RADIO AMATEUR CODE ● TELEVISION
- ELECTRONICS—1 yr. day course 2 yrs. eve. Day and Evening Classes. Booklet Upon Request.

New York Y.M.C.A. Schools
6 W. 64th Street New York City

RADIO ENGINEERING,

broadcasting, aviation and police radio, servicing, marine radio telegraphy and telephony, Morse telegraphy and railway accounting taught thoroughly. 48 weeks' Engineering course equivalent to 3 years of college radio work. All expenses low. Catalog free. School established 1874.
Dodge's Institute, Turner St., Valparaiso, Ind.

These Are the 6 Best Selling Short Wave Books . . . SEE THEM AT YOUR DEALER!

YOU buy parts, tubes, kits, accessories from your local radio dealer—that's what countless thousands of short-wave fans do. Through a nation-wide distribution service our numerous books are available at your favorite radio dealer—right where

you buy other radio equipment. It's more convenient, saves time and you can inspect the books before you buy. Ask your dealer to show you all the books advertised on this page—they're always in stock.

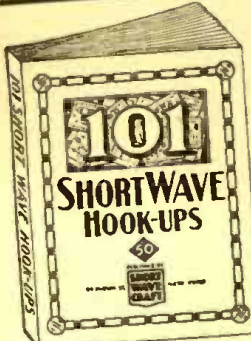

101 SHORT WAVE HOOK-UPS

Compiled by the Editors of **RADIO & TELEVISION**

Here is a worthwhile book that every short wave listener, every short wave fan, and every short wave amateur has wanted for a long time. It gives you the 101 best short wave hook-ups which have appeared heretofore.

100 Illustrations
72 Pages

50c



HOW TO BUILD AND OPERATE SHORT WAVE RECEIVERS

Including
Receivers for the Beginners
Short Wave Converters
S-W Superheterodynes
Super-Regenerators
Television Receivers

This is the best and most up-to-date book on the subject. It is edited and prepared by the editors of **RADIO & TELEVISION** and contains a wealth of material on the building and operation, not only of typical short wave receivers, but short wave converters as well.

150 Illustrations
72 Pages

50c



HOW TO GET BEST SHORT WAVE RECEPTION

M. HARVEY GERNSBACK tells you everything you have ever wanted to know about short wave reception. The author, a professional radio listener and radio fan for many years, gives you his long experience in radio reception and all that goes with it.

40 Illustrations
72 Pages

50c



10 MOST POPULAR SHORT WAVE RECEIVERS

HOW TO MAKE AND WORK THEM

The editors of **RADIO & TELEVISION** have selected ten outstanding short wave receivers and these are described in the new volume. Each receiver is fully illustrated with a complete layout, pictorial representation, photographs of the set complete, hook-up and all worthwhile specifications.

75 Illustrations
40 Pages

25c

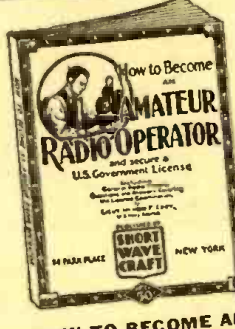

HOW TO BECOME AN AMATEUR RADIO OPERATOR

By Lieut. Myron F. Eddy, whose experience in the amateur field has made him pre-eminent in this line. If you intend to become a licensed code operator, if you wish to take up phone work eventually—this is the book you must get.

150 Illustrations
72 Pages

50c

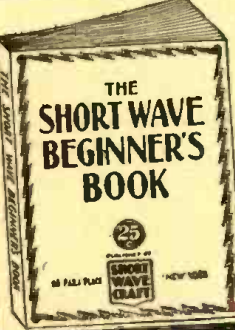

THE SHORT WAVE BEGINNER'S BOOK

Complete instruction in Short Wave for Beginners. Details for Making S-W Aerials, etc.

Here is a book that solves your short wave problems leading you in easy stages from the simplest fundamentals to the present stage of the art as it is known today. It is the only low-priced reference book on short waves for the beginner.

75 Illustrations
40 Pages

25c

LOOK FOR YOUR NEAREST DEALER

For convenience the publishers list below dealers in all parts of the world where our books are available. On your next shopping trip be certain to examine these volumes. You're sure to want them for your technical library.

- ALABAMA**
Weather Bros., Montgomery
- ARIZONA**
Sam's Cigar Store, Phoenix
- CALIFORNIA**
Electric Supply Co., Oakland
Radio Supply Company, Los Angeles
Radio Television Supply Co., Los Angeles
- FLORIDA**
Pacific Radio Exchange, Inc., Los Angeles
- ILLINOIS**
Western Auto Supply, Los Angeles
Zack Radio Supply Co., Los Angeles
Woman's Book Store, Pasadena
Western Radio & Elec. Co., San Diego
Scott Radio Supply, Long Beach
Offenbach Electric Co., San Francisco
Technical Book Co., San Francisco
Zack Radio Supply Co., San Francisco
Radio Specialties Co., San Jose
- INDIANA**
Interstate Radio Supply, Denver
- CONNECTICUT**
The Edward P. Judd Co., New Haven
- DELAWARE**
Wilmington Elec. Spec. Co., Inc., Wilmington
- FLORIDA**
Radio Accessories Co., Orlando
- GEORGIA**
Radio Wire Television, Inc., Atlanta
- ILLINOIS**
Allied Radio Corporation, Chicago
Walter C. Braun, Inc., Chicago
Chicago Radio Apparatus Co., Chicago
A. C. McClure & Co., Chicago
Midwest Radio Mart, Chicago
Newark Electric Co., Chicago
Sears, Roebuck & Co., Chicago
Max Stein & Co., Chicago
Montgomery Ward & Co., Chicago
Radio Wire Television, Inc., Chicago
- INDIANA**
Van Sickle Radio, Indianapolis
- MASSACHUSETTS**
DeWolfe & Fiske Co., Boston
The Personal Book Shop, Boston
Radio Wire Television, Inc., Boston
Library Book House, Springfield
Tremont Elec. Supply Co., Boston

- MICHIGAN**
Rissi Brothers, Detroit
- MINNESOTA**
St. Paul Book & Slat. Co., St. Paul
- MISSOURI**
Burrstein-Applebee Co., Kansas City
Radio Labs., Kansas City
Walter Ashe Radio Co., St. Louis
Van Sickle Radio Co., St. Louis
- NEBRASKA**
Radio Accessories Company, Omaha
- NEW JERSEY**
Radio Apparatus Co., Newark
United Radio Co., Newark
Radio Wire Television, Inc., Newark
- NEW YORK**
Port Orange Radio Dist. Co., Albany
Radio Wire Television, Inc., Bronx
Radio Wire Television, Inc., Jamaica, L. I.
Harrison Radio Co., New York City
American News Co., New York City
Baker & Taylor Co., New York City
Blair, the Radio Man, New York City
Adson Radio, New York City
Earle Radio Co., New York City
Federated Purchaser, Inc., New York City
Radio Circular Co., New York City
G. E. Stechert & Co., New York City
The Steiger Co., New York City
Sun Radio Co., New York City

- OHIO**
News Exchange, Akron
United Radio, Inc., Cincinnati
College Book Exchange, Toledo
- OREGON**
J. K. Gill Co., Portland
- PENNSYLVANIA**
The 437 Store, Philadelphia
M & H Sporting Goods Co., Philadelphia
Radio Electric Service Co., Philadelphia
Cameradio Co., Pittsburgh
- UTAH**
Radio Supply, Inc., Salt Lake City
- WASHINGTON**
Seattle Radio Supply Co., Seattle
Wedel Co., Inc., Seattle
- ARGENTINA**
Radio Revista, Buenos Aires

- AUSTRALIA**
McGill's Author. Agency, Melbourne
- BELGIUM**
Emil Arens, Brussels
- CANADA**
T. Eaton & Co., Winnipeg, Man.
Electrical Supplies, Ltd., Winnipeg, Man.
Wholesale Radio Supply, Winnipeg, Man.
Canadian Electrical Supply Co., Ltd., Toronto, Ont.
Radio Trade Supply Co., Ltd., Toronto, Ont.
Wholesale Radio Co., Ltd., 1133-35 Bay St., Toronto, Ont.
Canadian Electrical Supply Co., Ltd., Montreal, P. Q.
- BRAZIL**
Agencia Soave, Sao Paulo
- CHINA**
China News Co., Shanghai
International Bookellers, Ltd., Shanghai
- ENGLAND**
Gorrings's Amer. News Agency, London
- FRANCE**
Toute La Radio, Paris
- GERMANY**
Rehr G.M.B.H. SW15, Berlin NW No. 7
- HOLLAND**
Radio Peeters, Amsterdam, Z.
- INDIA**
Empire Book Mart, Bombay
- MEXICO**
American Book Store, Mexico, D. F.
Central De Publicaciones, S. A., Mexico, D. F.
Jaques Salvo, Mexico, D. F.
- NEW ZEALAND**
Johns, Ltd., Auckland
James John, Ltd., Dunedin
Te Aro Book Depot, Ltd., Wellington
- SOUTH AFRICA**
Technical Book Co., Cape Town
Central News Agency, Johannesburg
Consolidated Radio Co., Johannesburg
International House, Johannesburg
South African Radio Publications, Johannesburg

IF YOUR DEALER DOES NOT CARRY THESE BOOKS, ORDER DIRECT FROM US. FILL OUT COUPON BELOW. SHIPMENT WILL BE MADE IMMEDIATELY.

POPULAR BOOK CORP.
20 Vesey Street, New York City. R&T-9-41

Gentlemen: I enclose herewith my remittance for for which please send me the following books:

Name

Address

City State

(Send remittance in form of check or money order. If letter contains cash or unused U. S. postage stamps, register it.)

**20 VESEY STREET
NEW YORK, N. Y.**

RADIO & TELEVISION

Readers' Editorials

Uncle Sam Is Ready for Your License

● **COME ON, fellows, let's get busy—I mean you SWL's who plan to get your ham tickets soon some day but never get around to it—let's wake up and get those licenses.**

The majority of you have studied nearly enough radio theory to satisfy the F.C.C., and your code speed, with a few mistakes, isn't far from 13 w.p.m., but you haven't had the ambition to quite make the grade. Isn't it about time to quit fooling around and get down to business?

"Why the sudden hurry?" you may ask. In the first place, there's no sense in sitting on the sidelines watching licensed amateurs have the time of their lives, when you could have just as much fun yourselves if you'd really try. There's also a much more important reason.

The latest Gallup poll says that four out of every five Americans are convinced that we're going to war, and everyone knows that if that happens, we'll need a lot more than marching masses of riflemen to defeat a modern war machine. That's

This Month's Prize Winner

where radio hams enter the picture, because one of Uncle Sam's greatest needs is trained radio operators, technicians, and engineers.

The obvious place to look for these experts is in the F.C.C.'s files of the 56,000 American radio amateurs. A fellow won't help the Army or Navy much as a radio operator, if he can't even get a license to run his own ham station.

If you want to do your share for your country's defense, if you'd rather pound a key or tinker with wires than to wallow in mud in a front-line trench, why not start a blitzkrieg today on that theory and code so that when you're drafted, you can still follow your hobby in a job that's really important to the Army. Remember, anybody can be a buck private, but in 1941 only an expert can be an Army radio man.

ROBERT WAKEMAN,
51 Center St.,
Laconia, N. H.

Weak-Spots in Radio Education

● **NOW** that we are beginning to realize the vital importance of radio for defence, I believe everything possible should be done to assist those in remote rural areas, and those who have not the means to attend a good radio school, and who are depending on books and magazines for a radio education.

While there are good books on this subject, there are many which after explaining the principles of electricity and magnetism fairly well jump to complicated circuits, leaving the student with only a hazy idea of how it works and often discouraging him.

In fact I have seen men who were supposed to have a good radio training, who when given a circuit to explain, ran into difficulties even on simple parts of the circuit.

I believe **RADIO & TELEVISION** would be rendering these people a great service by running a series of articles, thoroughly explaining the principles of radio as used in the latest circuits.

And finally, if anyone thinks it is not worthwhile helping those who lack good educational facilities, let them look over a list of successful men and see how many of them started in this way. I say let's do everything in our power to help those who, in spite of handicaps, have ambition and initiative. Democracy needs them, so let's give them a chance to take their place in the world of tomorrow.

ARNOLD J. SLANEY,
Hawkshaw, R. R. No. 1, York Co., N. B., Canada.

We Don't Experiment Enough!

● **THE** radio enthusiast of today does not *experiment* enough. We follow the diagrams and plans that are found in magazines and books and we never create anything new.

We have all read about the effect that a change in grid potential has on the plate current in a vacuum tube, but, *how many of us have verified that fact?* Why not open up the "junk box" and hook up an old tube and several meters and see for yourself just what really happens.

*See page 320 for picture and description of set.

Prize Award

ADMIRAL 79-P6
3-Way Portable Receiver*
Value \$32.95

Awarded to Robert Wakeman
for his Guest Editorial
All others receive a year's
subscription.

This will give us a start along the right path. Don't sit back and simply *duplicate* the other fellow's work. Try those circuits you have in mind. You do not need gold plated parts, use old ones. Dismantle old sets for them, and you may turn out a circuit that is destined to become famous. If not, what have you lost?

So come on gang. Let us see what you can do.

BUTLER ROBERTS,
650 Chestnut St.,
Emmaus, Pa.

"High Fidelity" a Worthy Goal

● **TO** one who has made a hobby of studying high-fidelity reproduction of broadcast and recorded music, the present interest in that direction on the part of radio manufacturers, designers and acoustical engineers, as well as the listening public, holds a promise of new achievement. The current exploitation of *Frequency Modulation* in broadcast radio programs has undoubtedly stimulated much of the present interest in faithful sound reproduction, though there still exists some confusion as to what "high-fidelity" actually is and how it is obtained in home installations.

The class of radio listener represented by the writer, a professional musician interested in obtaining the best possible performance in terms of fidelity from his radio and record library, is quite naturally a small one. Add to this class, however, a small army of earnest amateurs who are just as insistent upon quality of sound, and you have a group of discerning listeners who will enthusiastically welcome any advances in the attainment of faithful reproduction of music. What is more, this group is sufficiently large to be taken into consideration as a factor in the purchase of new radio equipment.

Magazines such as **RADIO & TELEVISION** have been instrumental in bringing new developments and circuit design to the attention of those interested, and are to be congratulated upon the thoroughness with which these developments have been reported as fast

(Continued on page 319)

TELEVISION TRIES NEW TECHNIQUES AS WNBT GOES ON AIR

The maze of pipes shown in the accompanying photographs is a new filter in the NBC television transmitter located in the Empire State Building tower, New York. It makes possible the simultaneous transmission of signals from three transmitters—television, FM sound and high speed facsimile.

Within the large pipes are small copper tubes carrying signals from the transmitters to the antenna perched on top of the tower. The tubes are interconnected in such a way that the signals from one transmitter cannot "back up" into another transmitter

or interfere with the signals coming from it. The filter which is used under a special F.C.C. experimental license, is the first of its kind ever designed.

Also illustrated, is the new suitcase portable television transmitter which NBC is using to pick up outside events for broadcasting over WNBT. While this by no means replaces a big television truck, it affords greater portability and is extremely applicable for many purposes.

Also illustrated is a studio set-up for a television program. Notice that three pick-ups are being used together with a boom

microphone. Two of the pick-ups are stationary while the one shown at the center is mounted on a truck for "pan-up" shots.

Typical of the times was the recent presentation of "Bottlenecks of 1941," a play written and acted by privates and non-coms from the Signal Corps stationed at Fort Monmouth, N. J. Four of the lads are shown here as they appeared to the man at the "close-up mike." This scene shows a rookie who was a non-conformist and had some trouble until the sergeants found out that he had \$5.00 and knew the way to a bar.

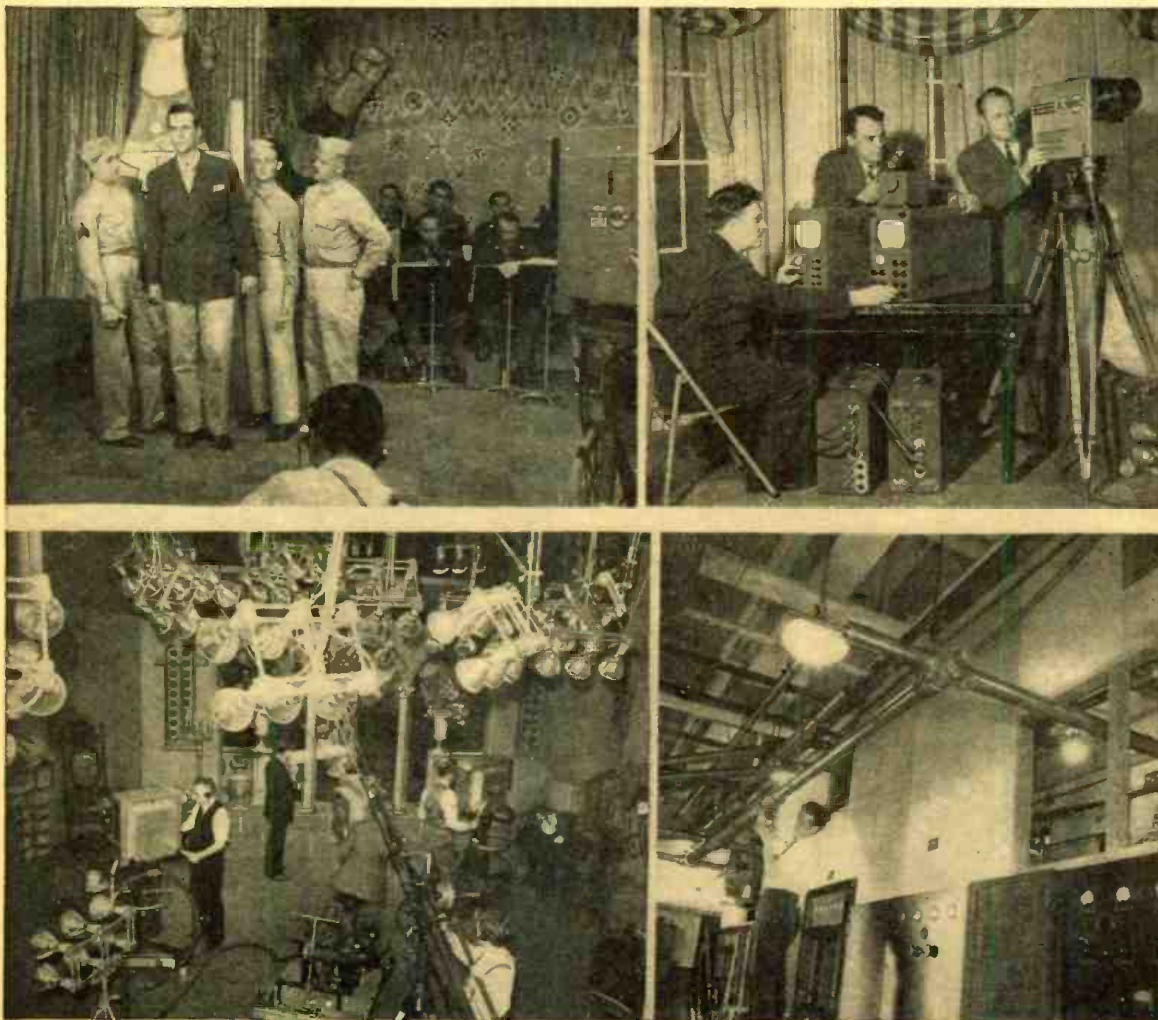

The pictures:—
Upper left—cast of "selectees" and "non-coms" in televised version of "Bottlenecks of 1941", an army show.

Upper right—new "suitcase" portable television transmitter for use in remote pick-ups.

Lower left—lighting a television set. Note camera positions and "dolly mke" in center.

Lower right—new filter used to carry three types of signals at the same time.

W3USA—W3USN FOR ARMY-NAVY HAMS

At the request of the War and Navy Departments, the Federal Communications Commission has authorized distinctive call letters for the Washington control stations of the Army and Navy amateur system networks.

W3CXL, control station for the Army Amateur System network, will hereafter be identified by W3USA. A new station to serve the same function for Naval amateur activities will be assigned W3USN.

The Commission waived its Rule 12.81 in view of military advocacy of more distinctive call signals to enable amateur radio operators in the Reserve Service to better identify these network control stations, particularly in the present emergency.

CBS CHANGES SHORT-WAVE SCHEDULE

The Columbia Broadcasting System has changed the frequency of its transmission. The new schedule is as follows:

WCBX

E.D.S.T.—Mondays through Saturdays: 8:00 a.m. to 1:00 p.m., 15,270 kilocycles, 19.6 meters, Europe; 1:30 p.m. to 3:30 p.m., 11,830 kilocycles, 25.3 meters, Europe. The remainder of the schedule remains the same.

E.D.S.T.—Sundays: 8:00 a.m. to 1:00 p.m., 15,270 kilocycles, 19.6 meters, Europe; 1:30 p.m. to 6:00 p.m., 9,650 kilocycles, 31.1 meters, Europe. The remainder of the schedule remains the same.

WCAB

E.D.S.T.—Mondays through Fridays: 1:00 p.m. to 6:00 p.m., 15,270 kilocycles, 19.6 meters, So. America. The remainder of the schedule remains the same.

E.D.S.T.—Saturdays and Sundays: 1:00 p.m. to 5:15 p.m., 15,270 kilocycles, 19.6 meters, So. America.

AMATEURS BURN AT FAVORITISM

Amateurs are beginning to feel somewhat resentful over the fact that a long chain of coincidences seems to have been affecting the assignment of call letters to certain prominent persons, particularly those in the motion picture industry. For example, Edgar Bergen has just been granted call letters for the radio in his private plane. The call letters are KHBCM, and BCM are, oddly, the initials of Bergen—Charlie McCarthy.

In former instances when amateurs mention when they get together is the assignment of KHJM to Jimmy Stewart, the movie actor, and KHSAB to Spangler Arlington Brugh, better known as Robert Taylor.

RADIO INCREASES PLANE SAFETY

The photograph herewith shows the new Azimuth indicator (to which arrow points) of the dual control automatic radio compass installed on the laboratory transport-type plane of the Civil Aeronautics Administration.

Each of the needles is actuated by one direction finder and these are tuned by the two light colored boxes, center above. The needle always points toward the station to which its receiver is tuned. Thus, when one finder is tuned to a station ahead, and one

to a station behind, the pilot can fly a straight course between the two stations by keeping the needle in a straight line across the indicator.

Navigation by radio direction finders which can be tuned to broadcast or radio range stations, is now permitted by the Civil Aeronautics Board along certain routes not supplied with radio range guidance. This permission presages flying by instrument in the "ocean of the air" rather than along narrow paths laid down by radio beacons.

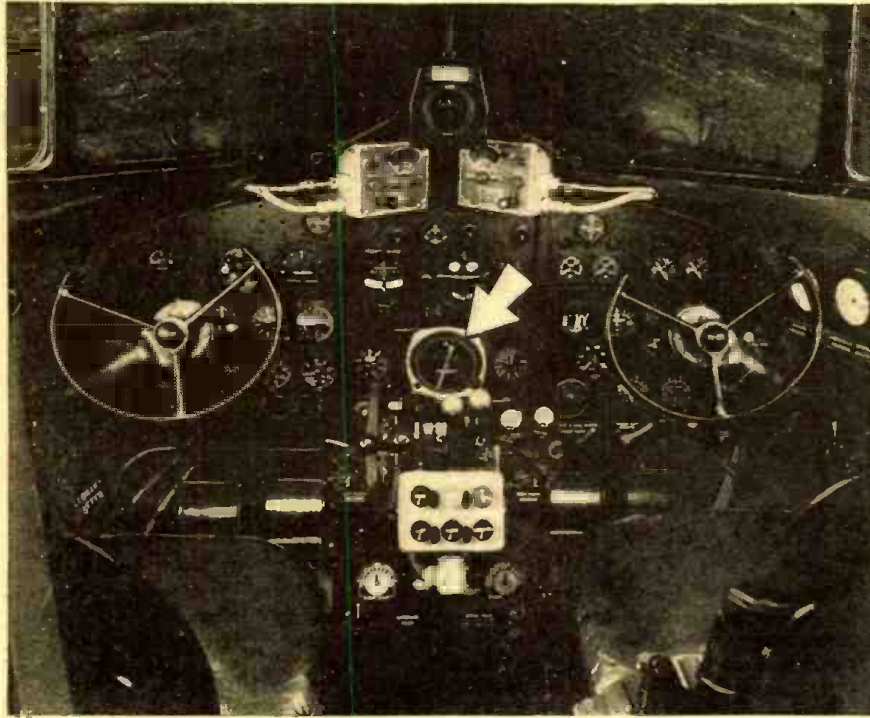

PICTURE SHOWS GROWTH OF BROADCASTING

A romantic—if not factually true—story of the broadcasting is given in Twentieth Century-Fox's highly entertaining picture, "The Great American Broadcast." According to this story, a Ham, played by Jack Oakie, is so enthusiastic about broadcasting that he talks a couple of entertainers (John Payne and Alice Faye) into putting on regular broadcasts in the hope that manufacturers of crystal sets will pay them a commission on the

increased sale which their singing will bring about. They manage to get enough money to put up their own transmitter and broadcast the fight between Jess Willard and Jack Dempsey. (Yes! The first fight broadcast was that between Dempsey and Carpentier some years later.)

However, the broadcast is a terrific success and everything runs along smoothly to the conventional happy ending with lots of pretty girls and a clinch at the curtain.

13 AMATEUR LICENSES SUSPENDED; 3 ILLEGAL STATIONS SEIZED

Thirteen licensed amateurs have been suspended for a period of 60 days by the F.C.C. because of violations of the emergency injunction against communicating stations in foreign countries. While there was no evidence of subversive activity, the licensees were proven to have engaged in international communication in direct violation of the Commission order A72. This rule was promulgated because of the National Defense situation and it was believed that through patriotism, if not through fear of the law, amateurs would obey it. However, the Commission's National Defense operators' section was on the watch and the thirteen following licensees were caught violating A72: James L. Waller, Pittsfield, Mass.; Halsey Walter Kline, Schenectady, N. Y.; Edward Anthony Gruler, Glendale, L. I., N. Y.; Charles Robert Hoffman, Jamaica, L. I., N. Y.; James Thomas Steele, Harrisburg, Pa.; Joe John Simon, Cleveland, Ohio; William E. Elder, Hamilton, Ohio; Clifford LeRoy Highfill, Indianapolis, Ind.; John Theodore Tyner, Glenview, Ill.; Ralph Edward Signaige, Madison, Ill.; Robert Jon Hessler, Western Springs, Ill.; Eldon F. Davidson, Coffeyville, Kans., and Oliver Ward, Junction City, Kans.

That the Commission is continuing to crack down on the use of unlicensed equipment is indicated by three additional cases uncovered.

By means of direction finding equipment and use of a mobile unit, unlicensed operation was found at Portland, Ore., and the operator, Jack Baldwin, 20, was arrested on June 14, and released on \$1,000 bond. All of his communications were directed to licensed amateur stations.

Through like means, an unlicensed operator was found in Los Angeles, where Carl Meeks, 26, was arrested on June 13. He, too, communicated with licensed amateurs.

Direction-finding equipment in a mobile unit also uncovered unlicensed operation at Sault Ste. Marie, Mich., and David Gregg was arrested there on June 10th.

The operators in each of the three cases mentioned were charged with violating Sections 301 and 318 of the Communications Act.



GUARDING THE ETHER

Though highly complicated to the layman the technique employed by the Federal Communications Commission in policing the ether lanes, now a 24-hour duty in connection with the national defense, is familiar to radio engineers.

To understand *how* the Commission patrols the ether, it is first necessary to know *why* this is done.

The Commission polices the ether traffic mainly through primary "monitoring" stations. These stations are really "listening posts" which, because of their geographic locations, can "hear" over the entire nation.

"Monitoring" to see that radio transmissions obey ordinary ether traffic rules has been a practice since the early days of radio regulation. However, normal functions of the Commission have now been augmented to meet national defense requirements. This supplemental duty is in charge of FCC's National Defense Operations Section, which was established July 1 of last year. Existing monitoring facilities also record foreign short-wave broadcasts for a special Commission unit, which translates and analyzes the programs so intercepted.

Each FCC monitoring station, in effect, patrols a particular ether "beat." Oftentimes such a station will itself spot an unlawful transmission. At other times suspicious signals are reported by broadcasters and other licensees—often by amateurs, who do an excellent job of policing their own bands.

No signal is too weak for a monitoring station to pick up and record. When a strange signal is detected on the ether lanes, "direction-finding" apparatus is called into play to trace the culprit.

Sometimes three or more stations will collaborate in thus getting a bearing on the suspicious signal. Their beams are plotted on a map. Eventually and inevitably two lines will cross. This point or "fix," marks the general location of the sending set under surveillance.

The final task of running down the offender is performed by FCC monitoring officers. Such men, highly skilled in radio engineering and radio operation, are assigned to monitoring units dispersed strategically throughout the United States and its possessions. For obvious reasons, locations of such auxiliary "ears" are not made public.

These monitoring posts are provided with automobiles, to all external appearance ordinary cars, but are fitted with the latest and most efficient type of detection equipment. Included are direction-finders, all-wave receivers, and recorders. All this apparatus can be operated from the car's battery while the auto is in motion or, upon being removed from the machine, from the power supply of a dwelling, tourist camp, store, etc.

Operation of the mobile equipment follows much the same procedure employed by the monitoring stations in the first instance. Directional beams finally "fix" at the exact location of the transmitter in question. Even if the hunt narrows to an apartment house, hotel, or other large building, an FCC officer can, by using a device concealed in his hand or in his pocket, proceed from floor to floor, and from door to door and so determine the exact room in which the illegal equipment is being used.

WHAT DO YOU KNOW?

Opposing teams of General Electric employees are quizzed on a weekly broadcast called "What Do You Know?" over W2XOY, Schenectady frequency modulation station. Opposing teams on the broadcasts, which include questions of general information of all subjects ranging from *abacus* to *zymotic*, are chosen each week from different departments in the

vast manufacturing and office departments.

At the right, acting as quiz master, is Joan Beckett, of the Publicity Department. She is a member of the committee which plans and produces the programs. (Answering the question, "What Do You Know?", we know that the little girl in the foreground is kind of cutç and we hope her answer was right.)



FACSIMILE REPLACES PHOTOSTAT

For offices who wish to make duplicate prints without the trouble and expense of photostating, a new facsimile transmitter-receiver has been designed in the Finch Telecommunications Laboratories. Known as Telefax, it is provided with two rollers. The original material is placed on the left-hand roller. A blank piece of paper is placed

on the right-hand roller, the arm, shown in raised position, is dropped to contact its surface, and the machine is started. A copy of the original is produced in a very few minutes.

It is said to be so simple that any office worker can operate it. Miss Ruth Reckway is doing the work here.

Below—a close-up of the facsimile duplicator. At right, the duplicator in use.



DCB SAFEGUARDS COMMUNICATIONS

James Lawrence Fly, who finds time amid his duties as chairman of the Federal Communications Commission to act also as chairman of the Defense Communications Board, has announced the completion of certain plans to prevent interruption of international radio and cable communications between the United States and foreign countries. These plans include the widening of "bottle necks," maintenance of auxiliary routes, circuits, and power supplies, message priorities, etc.

International communications service may be impeded in several ways, such as the cutting of cables, jamming of radio circuits, injury to equipment, cutting off power supplies, volume of message traffic in excess of capacity.

Most of the steps designed to prevent such interference must remain confidential. However, it can be known that supplies of reserve equipment and auxiliary power supplies are being collected while fast ships are ready to repair any breaks in cables. If unfriendly persons try to jam communications systems by sending a vast quantity of messages, this too can be overcome because priorities have been established for messages of military or other defense importance.

READING THE F.C.C.'S MAIL

The Federal Communications Commission is used to getting rather odd queries from radio listeners but occasionally even the stations themselves seek guidance on peculiar problems. For example, one broadcasting station was perplexed as to whether or not it was permissible to broadcast a "bellow-by-bellow" description of a bull-fight. Bull-fights are one of the few things the regulations of the Commission overlook. However, the F.C.C. points out that "broadcast programs which are offensive to the sensibilities of the people generally, are not in the public interest." And the F.C.C.'s letter goes on to say that bull-fighting is not legal in this country and that there is considerable public opposition to this form of entertainment in some sections of the country.

A chap in Washington, D. C., objects to the noise of a neighbor's radio which operates until 2 A.M. "Call the cops," says the Commission . . . A California woman says that radio and television signals permeate her home and person and make her ill. F.C.C. replies that many tests have been made and there is no proof that anyone has received any physical effect whatever at a reasonable distance from a transmitting antenna and recommends that she consult a physician. (Hey, F.C.C., we have heard some radio and seen some television programs that made us awful sick.) . . . A man in Massachusetts wants a frequency which he may use to control a bell in a garage a half-mile from his house. No provision is made for such applications.

Other woes referred to the Commission were those of a New Yorker who thinks stations' time rates are too high; another who objects to Sunday advertising and a third who wishes a magazine compelled to change its radio schedule in accordance with his own particular taste.

STATIC TEST?

We wonder how radio reception was on this car's receiver when three million volts of "tailor-made" lightning were directed against the auto which Dr. Gilbert D. McCann, research engineer, piloted through the Westinghouse high voltage laboratory at Trafford, Pa.

The stroke from the spherical electrode above the car streaked to the ground in

1/100,000,000 second, demonstrating the safety of the car during an electrical storm. At the background is seen the surge generator which produces the lightning used to test Westinghouse apparatus designed to safeguard power transmission systems from lightning. In the extreme foreground the bolt can be seen as it passes from the metal disc of the wheel over the tire to ground.



Picture at right shows man-made lightning striking a car in Westinghouse's experimental laboratories. Note path of stroke from electrode over car; to get to ground it jumps tire.

CBS ADDS 62ND "GOOD NEIGHBOR"

With the addition of Radio Nutibara—Station HJDT—in Medellin, Colombia, the Columbia Broadcasting System has forged the 62nd link in its Latin-American chain, binding nations of the Western Hemisphere for "solidarity through understanding."

Negotiations are also well under way to sign additional affiliates for the new "Network of the Americas"—"Cadena de las Americas"—which, according to Edmund A. Chester, CBS director of short-wave broadcasting and Latin-American relations, will provide programs for every one of more than 4,000,000 radio sets below the United States border.

Meanwhile, CBS engineers are pushing construction work on the two 50,000 watt transmitters for international stations WCBX and WCRC in Brentwood, Long Island. From this point, programs originating anywhere in the world are to be short-waved to Latin-American station affiliates for broadcasts within their own listening areas.

The two high fidelity stations will devote eight directional antennas exclusively for transmissions south of this country. Even though these are capable of 19 different broadcasting combinations, five other antennas, with 13 more broadcasting combinations, have been assigned to blanket coverage of Mexico, with provisions for shifting to short-wave toward Europe.

FM SYNCHRONIZER

The heart of the frequency synchronization system used by Western Electric to stabilize the output of the FM broadcast transmitters is this ingenious motor. It reacts to the electrical differential between the transmitter's oscillator and a crystal controlled circuit to hold the mid-frequency constant within .0025% of the assigned fre-

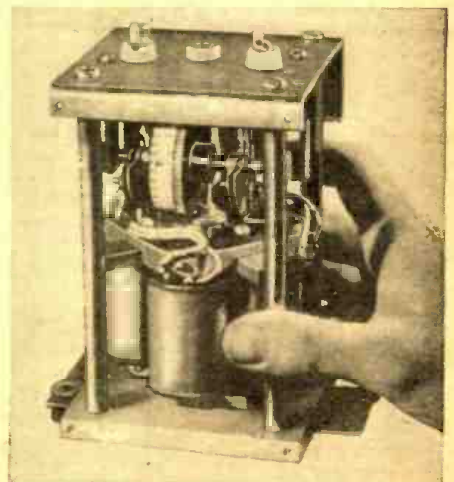

Compactness of unit is seen in comparison with human hand.

quency. The armature turns in jewelled bearings and transmits its motion to a miniature tank circuit through a precision worm drive.

BUILDING A "BUG" IS EASY TASK, SAYS BRITISH HAM

● A SEMI-AUTOMATIC key for those who wish to go in for code transmission can be built at home by anyone skilled in the use of tools. Such a key—and a very handsome one, too—is described by H. G. Newland in *Television & Radio Bulletin* of Britain. The top and side view of the key are shown in Fig. 1.

The construction is as follows: The base, as illustrated in Fig. 2, should be made of

one below each of the two pillars supporting the movable dot and dash contacts; another above and below the base of one terminal and the seventh below the bottom of the other terminal, to bring it level with its neighbor.

A 1 inch length of thin clock spring was used for the pendulum spring. For the "U" shaped spring, a piece of phosphor bronze strip measuring $1\frac{3}{4} \times \frac{3}{16}$ inch will be

inch brass rod, each one inch long, used for adjustment and contact supports. Two are drilled and tapped $\frac{1}{4}$ inch from one end while the third is slotted at one end to a depth of $\frac{1}{2}$ inch and a width of $\frac{1}{8}$ inch. The tapped holes take the adjustment pins while the slot clears a washer forming the stop at the weight end of the piece of $\frac{1}{8}$ inch rod previously mentioned. The washer is riveted to the slot by means of a $\frac{1}{8}$ inch

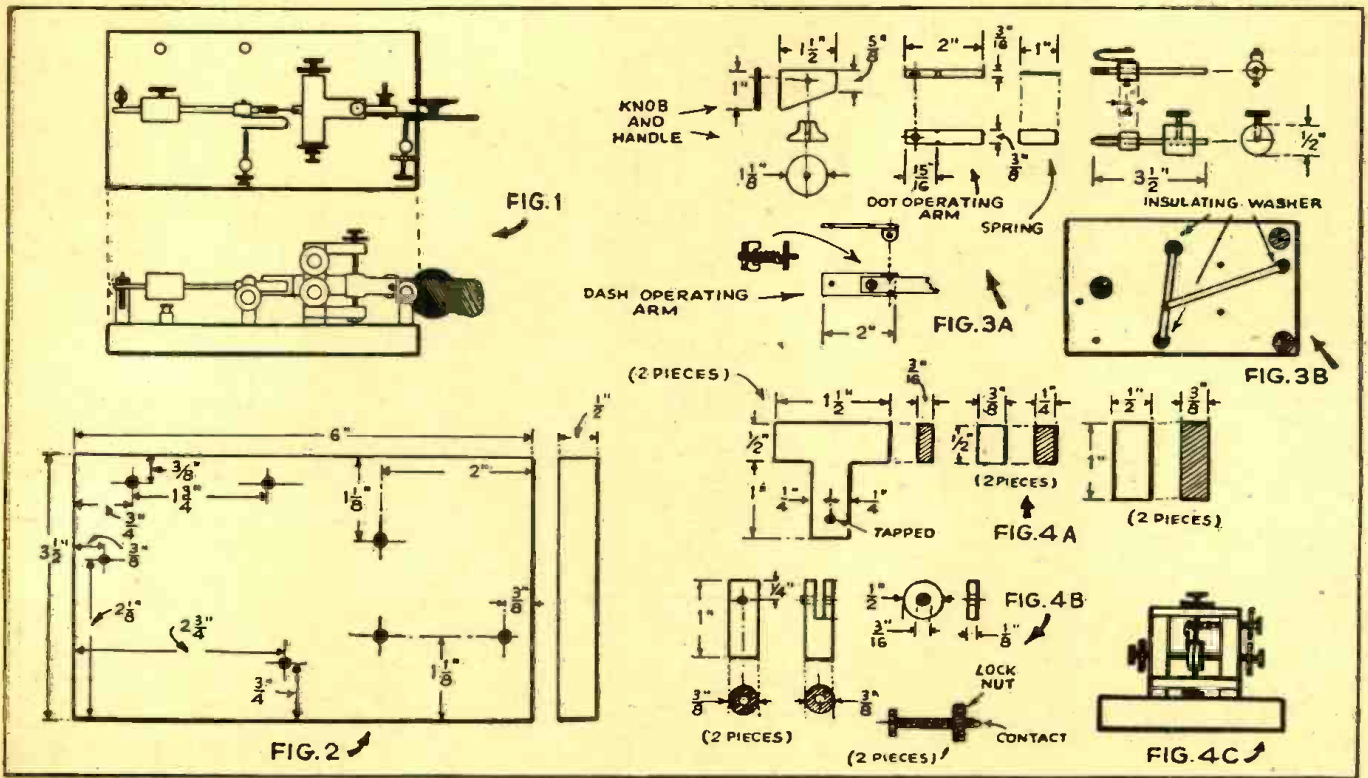

solid brass or other metal. All holes must be drilled to clear 6/32 screws.

In Fig. 3-A you will see the important details as to the dimensions for the spring, knob, handle, and the two arms. The weight, which is used to adjust the speed of the dots, is made from $\frac{1}{2}$ inch solid brass rod, $\frac{1}{2}$ inch long and is drilled to slip over a piece of $\frac{1}{8}$ inch brass rod $3\frac{1}{2}$ inches long. The brass weight is also tapped to take a 6/32 screw. (One with a large head such as those found in old binding posts should be used to make adjusting easy.) The "dot" handle is made of $\frac{1}{8}$ inch sheet bakelite or hard rubber measuring $1\frac{1}{2} \times 1$ inches, while the knob can be taken from an old telegraph key.

Seven insulating washers are also needed in the following positions: One above and

satisfactory. A contact is riveted to one end while the other is soldered to the adjustable carrying piece. This arrangement is shown in the right-hand corner of 3A. Under base connections for which short brass strips are used is shown at X in 3B. The writer suggests that the instrument be provided with rubber feet to afford clearance for such connections.

The bridge should be made of a solid brass block or can be constructed from six small pieces. Fig. 4A gives the dimension of the three pairs of component parts used in the bridge. The two small spacers measuring $\frac{1}{2} \times \frac{3}{8} \times \frac{1}{4}$ inch raise the assembly to afford access to the adjusting screw. The pieces may be screwed or soldered together but must be accurately aligned.

Fig. 4B shows the three lengths of $\frac{3}{8}$

inch rod, so that it can revolve easily. The other end of each of the three supports is drilled and tapped 6/32. The two adjusting pins shown at the bottom of 4B are made from 6/32 rod $1\frac{1}{8}$ inches long, a round knurled nut being sweated to one end of each and an additional locknut being provided. It is suggested that the pin at the top of bridge and that the set pin at the bottom of the "T" piece forming the lower bearing be made of threaded steel rod.

The four contact points required, one of which has a rivet base, the other being provided with screws, are obtainable from magneto repair companies and should be made of tungsten. Otherwise the illustration should be sufficiently clear to permit the easy construction of this unit by the average radio experimenter.

INTERESTING CRYSTAL CIRCUIT PRODUCES AMAZING RESULTS

● A TWO-CIRCUIT crystal set which costs but little to construct is described in *Australasian Radio World* as having been constructed by N. F. Jones of Brisbane. The primary coil consists of No. 24 D.S.C. wire on a 3-inch coil form. After the twelve turns have been wound, two holes are punched in the form and the end of a No. 30 wire is secured. Then the winding is continued with both the No. 24 and No. 30 for the next 25 turns. Then the No. 30 is terminated and the No. 24 wound for another thirteen turns.

The No. 24 is the antenna coil and has

two antenna terminals, no ground being connected to it. It is tuned by a .0005 mf. variable condenser. The No. 30 wire sec-

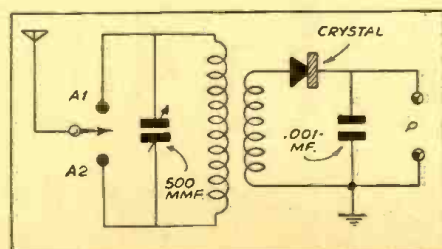

ondary coil is connected to ground as shown and the phones are shunted with a .001 mf. fixed condenser. Mr. Jones states that this circuit is not new, but that it is the best crystal receiver he has ever used.

WOMEN RADIO ENGINEERS

● THE B.B.C. recently advertised for a number of women operators for the staff of the engineering division. They should be between 21 and 35 years of age, should "preferably have some knowledge of elementary physics and electricity and possess a keen interest in broadcasting."

4-TUBE VIBRATOR SET WORKS ON ANY 6-VOLT SOURCE

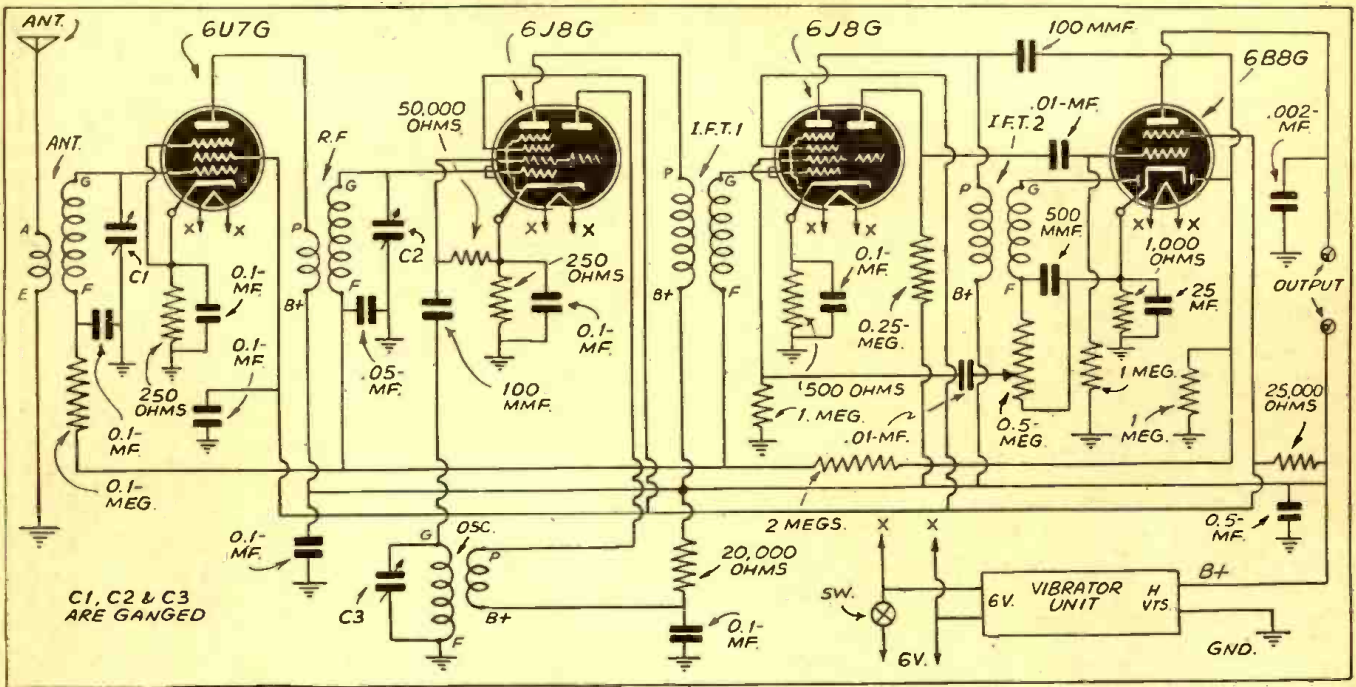

● FOR use as an automobile receiver or in country homes where the only light supply is from a 6-volt storage battery, the *Australasian Radio World* suggests the set shown here. Standard intermediate frequency transformers may be employed, and

plug-in coils for the antenna and R.F. stages will permit the set to be used for short waves when installed in the home. It is suggested that the vibrator unit be mounted in a shielded can and located at least four feet from the receiver. The author

points out that separate biasing resistors and bypass condensers are provided for each stage in order to stabilize operation, as vibrators are not ordinarily regulated as well as the output of "B" batteries or a power supply.

SHORT WAVE RECEIVER IS ECONOMICAL

(Correction Notice: The following text should have appeared with the diagram on page 203 of the August issue. The cut which should have accompanied last month's text appears on page 318)

● MEMBERS of the All-wave All-world DX Club of Australia have devised a special receiver for short wave use. They say it has very low noise-level with "tons of gain." Nevertheless it has been designed to provide excellent appearance and economy of manufacture and operation. The tube line-up is a 6U7G as R.F. amplifier, a 6J8G as converter, pentode portion of another as I.F. amplifier and the triode as audio amplifier. The output tube, a 6B8G, not only works as diode detector but also as output tube. The rectifier is a 5X3G. The antenna R.F. and oscillator coils are standard and short wave coils which may be of the plug-in type. The speaker has a

2500 ohm field coil and is fed through an input transformer, which has approximately 20,000 ohms plate impedance. Constructors are cautioned to watch length of the ground leads on the trimmer condensers, especially as these must be kept to a minimum length. They are also warned to use well insulated wire as the plate voltage is 325 volts.

AN IMPROVED IMPEDANCE MEASURING BOX

● THE Civil Aeronautics Authority at Washington, D. C., has made public the circuit of an improved impedance measuring box, a diagram of which appears here.

A very careful calibration of the condenser and use of a precision resistor insure the accuracy of the instrument and the meter used is a Weston Thermo-Galvanometer with an 0-115 ma. scale. A vacuum tube

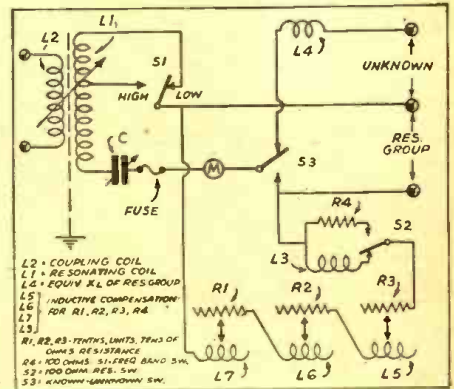

rectifier was omitted because of the weight of the battery and because of the possible disturbance of the resonant circuit by the inter-element capacity of the tube. The resistance of the meter is 5.2 ohms and the fuse required for its protection is 8 ohms.

Can YOU Answer These Radio Questions?

1. What is the newest application of facsimile? (See page 264)
2. Where is the Du Mont television station located and what is the height of the antenna? (See page 268)
3. How many thousand miles do the radio signals jump in the transmission of photos from Moscow to New York? (See page 270)
4. What is the particular advantage of using plug-in coils in a short wave receiver? (See page 274)
5. Why are tubular type condensers unsatisfactory for use in high frequency transmitters? (See page 283)
6. What is the effect of "pulling" in a superheterodyne circuit and how it can be put to work in a frequency modulation transmitter system? (See page 288)
7. How would you connect two aerials so as to combine efficient short-wave and broadcast reception, without the use of a switch? (See page 292)
8. What is meant by the term polarization in connection with the transmission of frequency-modulated waves? (See page 294)
9. How would you arrange to obtain regeneration in the second detector of a superheterodyne receiver? (See page 302)
10. What is the "slide-wire" bridge and what electrical quantity does it measure? (See page 306)
11. Can you describe a simple sure method of determining the different wires of a cable, using apparatus easily available? (See page 304)
12. Can you explain simply the action of the noise eliminator circuit in a radio receiver? (See page 313)

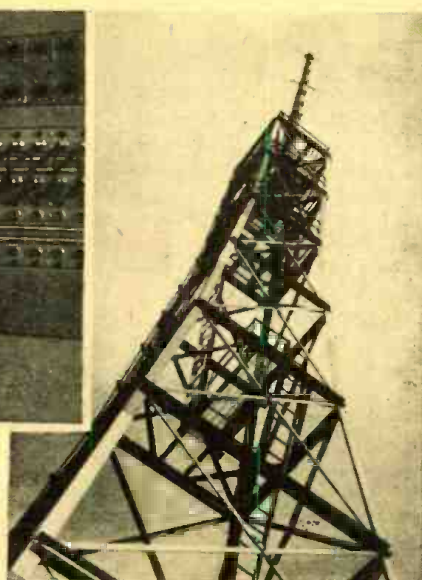
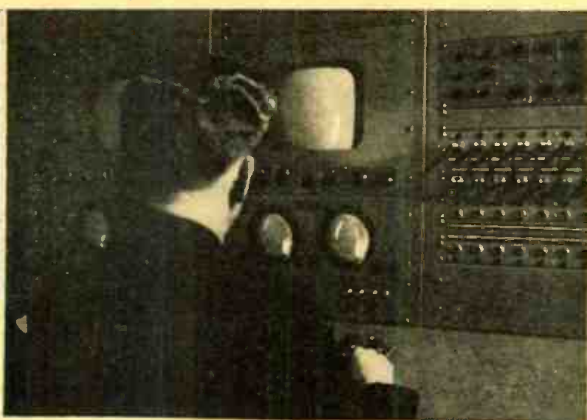

DU MONT VISION STATION

● CAMERAS used in the Du Mont television station at 515 Madison Avenue in New York City, are shown in one of the photos. Station W2XWV is provided with ample camera equipment for both studio and "outside" pickups. These Du Mont cameras of the latest model are provided with the exclusive electronic view finder, which provides the cameraman with an exact checkup of what he is picking up in television terms. Virtually a miniature television, this view-finder fastens at the side

of the camera, and can be tilted at any angle for ready viewing by the cameraman. "Taking" lenses can be changed without having to make any change in the electronic view-finder, which instantly indicates just what the camera is picking up.

A second photo shows operator monitoring "movie" programs at the Du Mont television station W2XWV. This equipment, built by Du Mont, is a dual film chain, permitting of handling two film pickups simultaneously if desired. The operators monitor

the film pickup by observing the actual television images on the large screens, and the signal details on the smaller screen.

The lofty steel tower and most of the Du Mont television station in New York City is shown in left-hand photo. The mast can be raised and lowered to the platform atop the steel tower, for maintenance. The tower is on the roof of a 42-story skyscraper, and dominates the metropolitan New York area, accounting for powerful signals virtually throughout the vast area.

CBS Teaches Dancing by Television

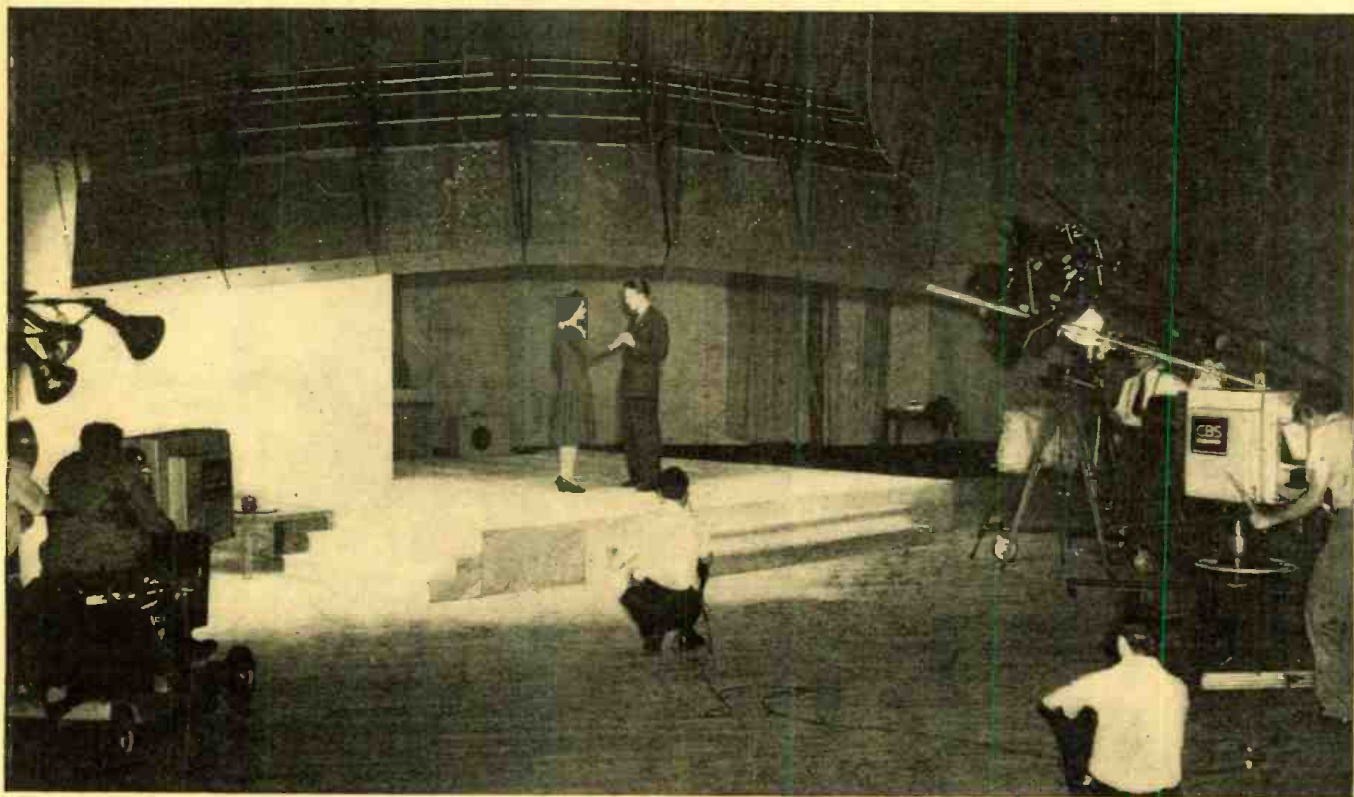

● AN Arthur Murray dance instructress teaches the latest steps to her pupil as television cameras pick up the scene in the CBS Television studio in New York City.

"Dancing Lesson," a regular CBS television program, is designed to give the viewer dancing instruction and also an opportunity to watch others learning to dance. The pro-

gram originates from the CBS television studio where the television cameras record the pitfalls and progress of the novice dancers.

NEWEST TELEVISION AERIAL

Front Cover Feature



● THIS queer-looking contraption is in reality an antenna for the General Electric television station, W2XB, in Schenectady. The antenna, shown above in the process of assembly indoors, is now mounted atop the 128-foot tower on the studio grounds at State Street and Washington Avenue in downtown Schenectady, where it will be used to relay television waves to the transmitting station in the Helderberg Mountains 12 miles away. Protected from rain and snow, the 13-foot tall, four-foot

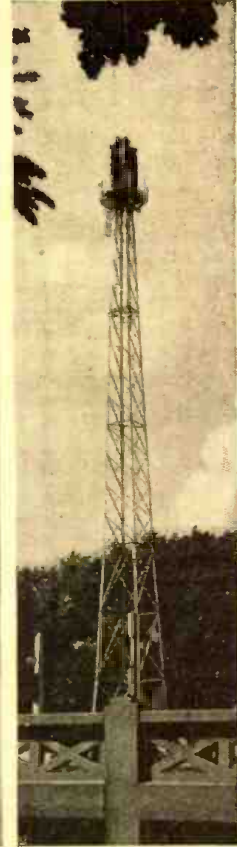

The three photos show the newest Television aerial developed by G.E. Co. engineers, and erected at station W2XB in Schenectady. The tower is 128 ft. high. This antenna will relay television programs to the transmitting station in the Helderberg Mountains, 12 miles away.

square box required the talents of a carpenter, plumber and engineer to construct. Engineer M. L. Scheldorf is shown pointing at the ladder-like antenna proper, which

is made of brass tubing and copper bars. Arthur J. Reardon, a carpenter, is shown on the ladder, and Charles V. Holoska, a plumber is sitting on the cross-bracing.

Television Entertainment Afloat

● MOVIES, sports, spot news and entertainment are now brought aboard small pleasure boats by means of television. That this is entirely practical and not just wishful thinking or prophesying the remote future, is being demonstrated these days by Allen B. Du Mont, pioneer television engineer and manufacturer, who has installed one of his receivers aboard his 33-foot cabin cruiser the "Hurricane II".

A standard Du Mont table model television has been placed on a cabinet to one side of the main cabin, facing a settee and several chairs. The 110-volt A.C. current supply is furnished by a generator driven by the two Chrysler engines that propel the boat. As many as a dozen persons can be entertained by the 8 x 10 inch vivid images appearing on the teletron screen. Using a dipole antenna on the ship's main mast, the New York City television stations are being picked up at distances up to and frequently exceeding 50 miles. Excellent sight-and-sound reception is being obtained from the Du Mont station W2XWV, the tall steel tower of which extends high above

Allen B. Du Mont has this 8 x 10 inch image television receiver installed on his yacht. Excellent reception is reported.



the 42-story skyscraper at 515 Madison Avenue.

"Television is bound to be a 'must' for the well-equipped pleasure boat, be it cabin cruiser or ambitious yacht", states Mr. Du Mont, an enthusiastic yachtsman when he isn't working at television and cathode-ray oscillography. "Even at this early date in the commercialization of television broad-

casting, the movie, sport, spot news and entertainment programs are just the diversion which we need aboard boat during the evenings, especially when anchored in some strange spot. Television pretty much brings the mountain of entertainment to the yachting Mahomet, and as such it has a real place in the growing and more elaborate appointments of the pleasure boat."

● SUCCESSFUL reception of the first radio-pictures from Moscow has inspired the engineers of R.C.A. Communications, Inc., to continue the tests, the outcome of which, it is hoped, will lead to establishment of a regular commercial radiophoto service between the United States and Russia. It is explained that the 4,615 miles circuit between New York and Moscow passes through one of the most turbulent magnetic regions in space and, therefore, much depends upon atmospheric conditions.

Appearance in the American press of Soviet war scenes quickly followed the announcement that radio is carrying pictures out of Moscow, flashing them over the heads of the Nazis across the battle zones, over Poland, over Germany and across the Atlantic to New York. They are received at "Radio Central" at Riverhead, Long Island, for relay to the radiophoto machines of R.C.A. Communications, Inc., in New York City.

As a result, instead of the photographs being delayed for days in transit, American newspaper readers have seen Russian war pictures a short time after they were taken. Columns of Russian troops, captured German aviators, and a Russian anti-aircraft gun crew were seen. Also among the news views was a Nazi plane wrecked on Soviet soil—a bomber which had flown out of the Reich, but flew back across it in a picture that revealed its fate.

Moscow has become the fifth addition to the RCA radiophoto circuits, the others being London, Berlin, Buenos Aires and Tokyo. Observers now note that radiophoto service is world-wide, and military commentators, recalling there were no pictures on the wavelengths during the first World War, see new advantages to be gained on the side of truth. They point out that Berlin has taken every opportunity to use radiophoto circuits for international dissemination of pictures. Now it is expected that, with Russia broadcasting pictures, the photographs of the battle-fronts will not appear to have been taken only from one side of the line.

The long-distance flight of pictures from Moscow to New York is no overnight development, the engineers point out, but is the result of many years of research and development in RCA Laboratories.

Today, the technicians describe their magic as simple. For instance, in Moscow or at any of the other sending terminals, the picture is wrapped on a cylinder. The lights and shadows are made to actuate the radio transmitter which sends corresponding impulses varying in accordance with the dark areas and highlights of the picture. As the cylinder revolves, gradually the picture is dissected by a tiny needle or pinpoint of light. Simultaneously, at the distant receiving station, a cylinder is revolving at the same speed, and on it is wrapped a "negative" or paper sensitive to the incoming impulses. As this cylinder turns a pinpoint of light, actuated by the incoming radio energy, reconstructs or "paints" the picture line by line exactly as it is transmitted. It takes about twenty minutes for the pen to run the length of the cylinder, and when it does, the picture is complete.

Photos at top of page show samples of radiophotos received via RCA system from Moscow. Pictures at right show operation of similar system between New York and London.



RADIOPHOTOS from Moscow

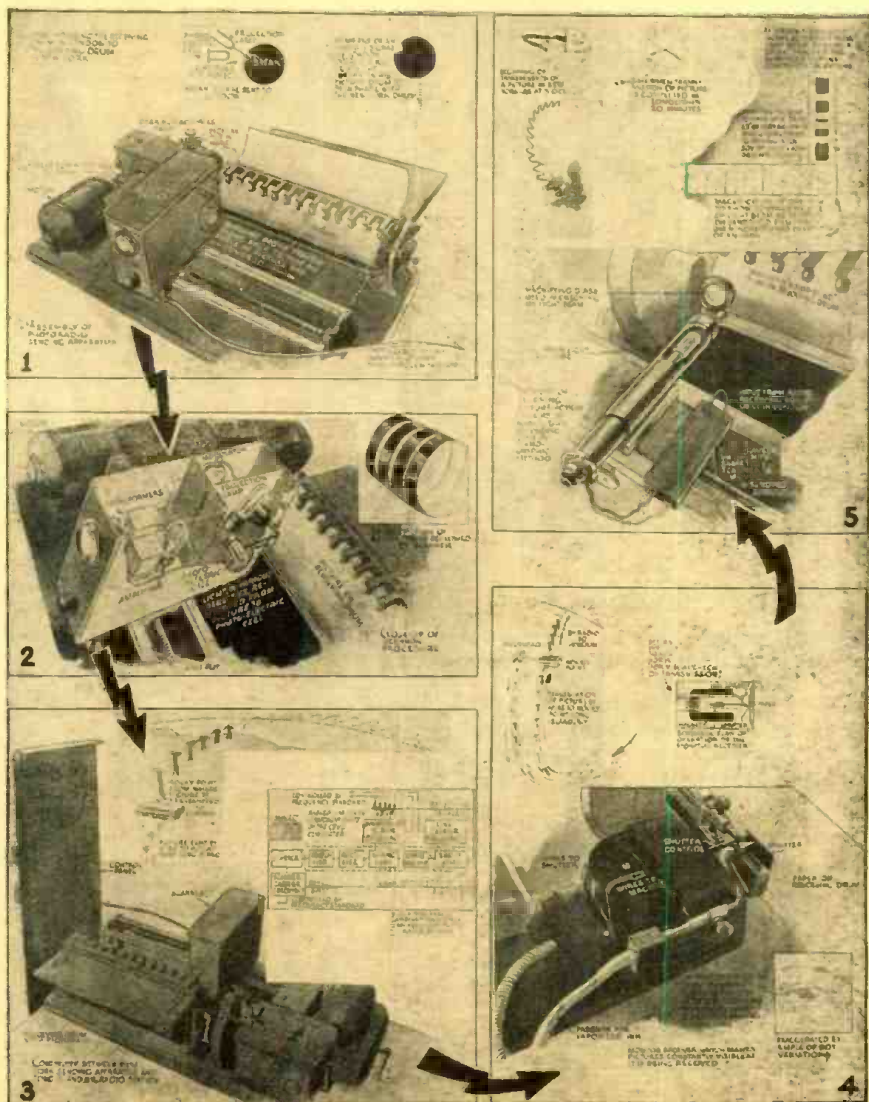

GET YOUR *hallicrafters* SET FROM ALLIED

Send for Allied's Free 1942 Fall and Winter Catalog Biggest in Radio!



Amateur net,
\$149.50
\$37.38 down
\$14.86 monthly
for 8 months

The Sky Traveler, Model S-29 (Below)

Now you can take your communications receiver with you wherever you go. The Sky Traveler operates on either 110 volts AC or DC or from self-contained batteries. 9 tubes, 4 bands, covers from 550 kc. to 30.5 mc., self-contained collapsible

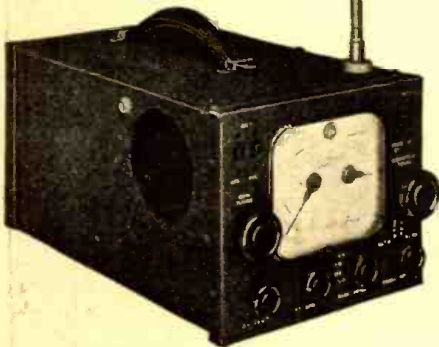

YOU CAN TAKE IT WITH YOU WHEREVER YOU GO!

antenna, RF stage on all bands, high gain antenna coupling circuit for maximum antenna energy transfer, one piece chassis designed for the greatest rigidity consistent with the least weight. Weight including all batteries: 18 lbs.

Amateur net,
\$59.50
\$14.88 down
\$7.88 monthly
for 6 months

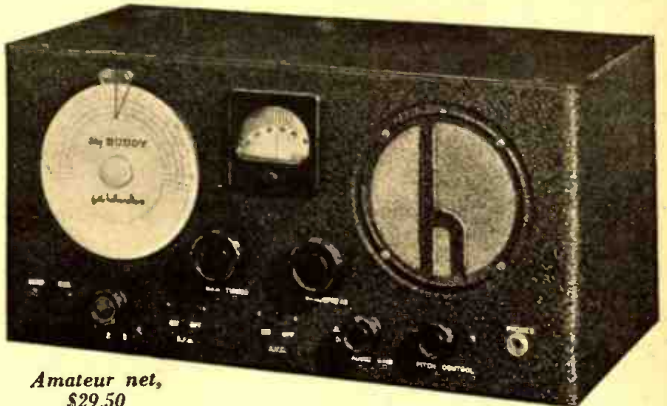

Amateur net,
\$29.50
\$7.38 down
\$5.86 monthly for 4 months

The Sky Buddy, Model S-19R (Above right)

Covers everything on the air from 550 kc. to 44 mc. The Sky Buddy is designed to produce superior performance at a moderate price. 6 tubes, 4 bands, electrical band-spread, self-contained 5" dynamic speaker, built-in line filter, band switch, AVC switch, send-receive switch. Compare the Sky Buddy with communications receiver selling at anywhere near this price.

You can always depend on Allied for courteous service, complete stocks, and prompt shipment.

NEW!
COMPLETE!
212 PAGES!
ALLIED'S
1942 FALL AND
WINTER CATALOG
Free!

ALLIED RADIO

Send for your FREE copy today!

ALLIED RADIO CORPORATION

Dept. 3-HJ-1, 833 W. Jackson Blvd., Chicago, Ill.

- Please send your New 1942 Fall Radio Catalog FREE.
- Please ship the Skyrider 32 \$..... enclosed
- Please ship the S-29. \$..... enclosed
- Please ship the S-19R. \$..... enclosed

NAME

ADDRESS

CITY STATE

Battery Short-Wave Receiver

Joseph Hiatt

The hook-up for this short-wave battery-operated receiver is the result of many different experiments by the author. The set operates a loudspeaker and due to the use of plug-in coils, any band can be quickly switched in.

● TO the veteran short wave fan this set might seem a duplication of the pioneer Pilot Wasp, which by the way was the best all around circuit yet devised at that time. But while the Pilot Wasp was built on a conventional short-wave basis, that part of it has been carried over into this set and dedicated solely to the *beginner*, who expects loudspeaker results from four tubes of the battery type.

In reality this is a combination of several different circuits, so fitted together that perfect harmony exists, without any delicate adjustments that are continually departing from the intended path. This circuit and dozens of other combinations have been thoroughly tried out, with different locations of the many parts, and this plan was found to be by far the most simple and efficient of all. The writer has brought in London, Berlin and Rome on the loudspeaker with sufficient volume to be plainly audible throughout the whole apartment, with only a home-made loop for an antenna—and all inside a brick building. (Richmond, Indiana.)

The "30" tubes have been adopted as they are less critical for the beginner to install and operate, while using the minimum of "A" battery drain. The screen-grid

1A4 is used for a radio-frequency tube, as in this location it is not delicate or touchy, yet damming back the oscillations of the detector tube from the antenna or "whistling" in the neighbor's outfits. The detector and two audio tubes are 30s, as the 30 detector can easily be followed by audio transformer coupling, which eliminates many complications. The transformer coupling has been adopted on account of the superiority it holds over resistance-coupling, so far as simplicity and efficiency are concerned.

The fixed condenser C7 at first would seem unnecessary, but is installed here as a balance to the inductance and capacity of the antenna and detector tuning circuits; once synchronism between the two circuits is established, it remains permanent.

The loading resistances in the plate circuits in series with the primary coil of the transformer, serves to combine the transformer and resistance coupling, a feature that seems to add a balancing effect that is highly desirable.

A certain amount of consideration was given toward making this a *portable* set, but efficiency was at no time made secondary or lost sight of.

The *regeneration control* is of the varia-

ble condenser type, as it proved by experiment to be superior to the potentiometer type.

The output tube may be a 33, but experimentation proved that the 33 (with its double filament) consumes twice the A battery current of the 30, with no appreciable increase of volume or efficiency.

There is only one feature of this hookup that is at all critical, and that is the adjustment of the 50 mmf. antenna condenser. This is not difficult if operated in this manner: tune in some local amateur who is working code and sending a very strong signal, turn the regeneration condenser IN until the signal is scarcely audible, then turn the antenna condenser back and forth until the signal is loudest—and this is the required adjustment. By turning the regeneration condenser in, the adjusting of the antenna condenser will not throw the circuit out of oscillation.

The 1A4 radio frequency tube and the 30 detector tube are *shielded* as well as the two coils.

The two sockets for the coils should be mounted on $\frac{3}{8}$ " outside diameter bakelite tubing $1\frac{1}{2}$ " long, to raise the coils away from the metal base. The detector socket should be mounted on $\frac{3}{8}$ " tubing $\frac{3}{8}$ " long. All

Wiring diagram of the flexible short-wave receiver here described.

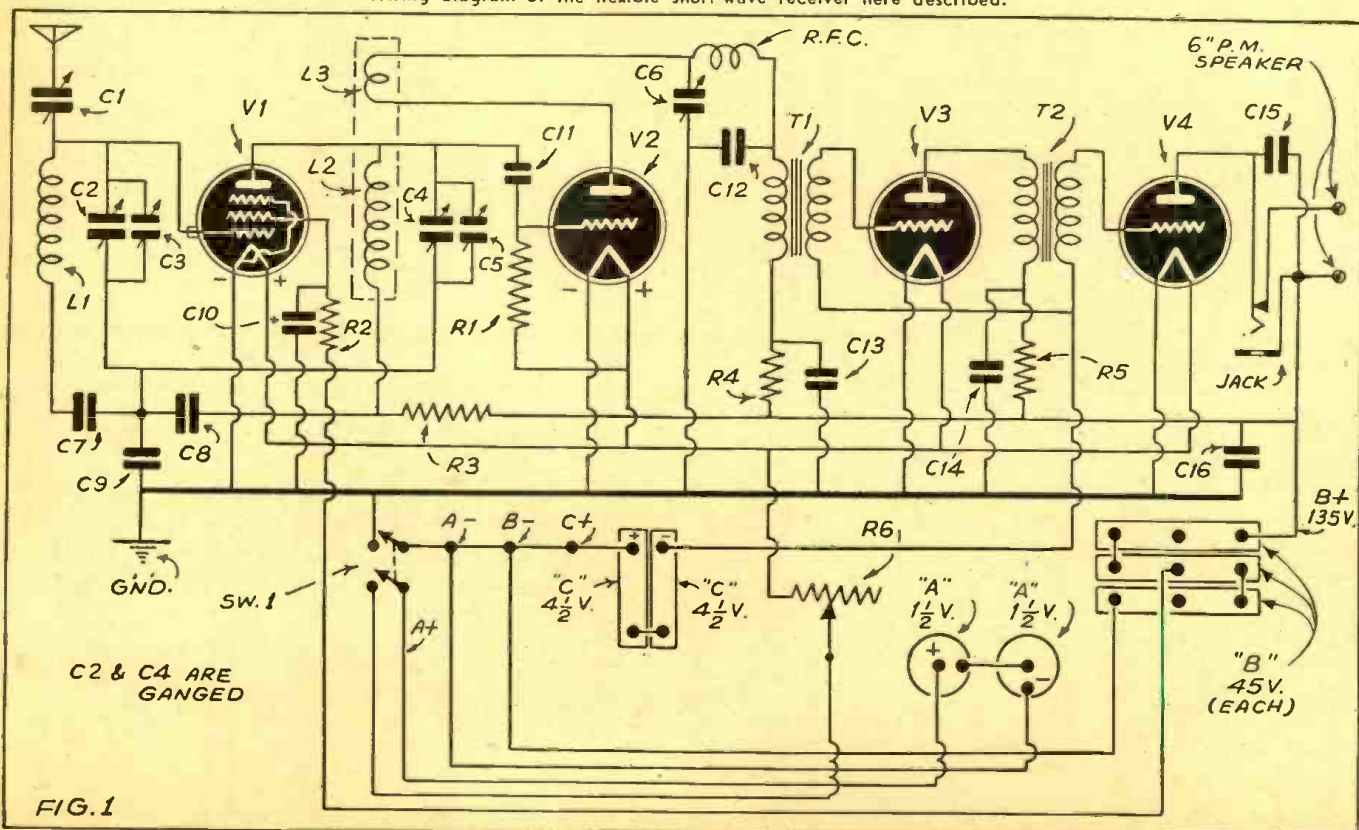

FIG. 1

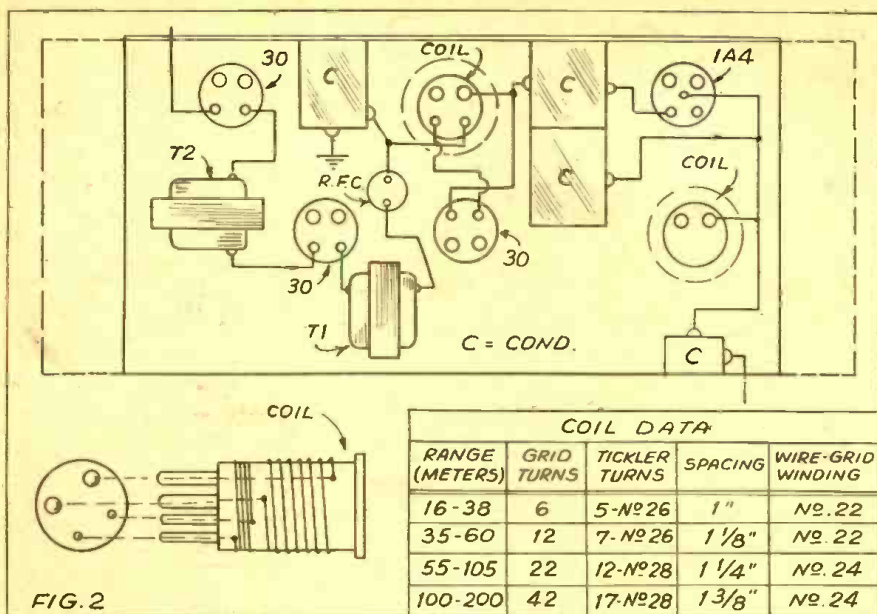

FIG. 2

Suggested layout of the parts in the short-wave receiver.

sockets should be mounted on plumber's 1/2" valve washers of soft rubber, to eliminate vibration from slight shocks.

The ganged tuning condensers, as well as the trimmers and phone jack, must be thoroughly insulated from panel and base. The ground connection from the rotors are connected directly through C7, C8 and C9 to the ground. Insulating washers of the shouldered type are made especially for this purpose, and are readily obtainable from any supply house. A special ground wire of about No. 12 bare copper should be installed under the base, within easy reach of all parts that are connected to the ground, and securely soldered with the ground post, solder all other connections as they are made.

In Fig. 2 is found a suggested layout of the component units to build up the set, this layout was found to be the most successful by experiment. This shows the line-up by laying in the plate and grid circuits complete, from the antenna condenser to phone jack or loudspeaker. The author would recommend that all the required units be in hand and placed with a view of keeping all plate and grid connections as short and direct as possible, yet easy to reach with the soldering iron; enabling the constructor to use No. 22 bare copper wire, thus easing the difficulty quite a lot.

The dotted lines in Fig. 2 show where the base ends are bent down on the same line the panel is bent up, dimensions to be determined by the constructor. The distribution of the grid tuning coils and transformer coils is such, that neither will react on the other to cause any difficulty.

LIST OF PARTS

HAMMARLUND (Variable Condensers)

- C1—50 mmf. Star Midget.
- C2 and C4—140 mmf. dual midget 2 gang midget.
- C3 and C5—15 mmf. star midget.
- C6—320 mmf. type MC midget.

I.R.C. (Resistors)

- R1—3 megohm bias gridleak.
- R2—5000 BT-1 resistor.
- R3—10000 ohm BT-1 resistor.
- R4—15000 ohm BT-1 resistor.
- R5—20000 ohm BT-1 resistor.

R.C.A.—Tubes

- V1—1A4 2-volt screen-grid tube.
- V2, V3 and V4 2-volt #30 tube.

THORDARSON

- T1 and T2—3 to 1 audio transformers.

KNIGHT

- 1—6" PM dynamic speaker.

YAXLEY

- SW1—DPST switch.

SPRAGUE (By-pass Condensers)

- C7, C8, C10, C13 and C14 .01 mmf. bypass condenser.
- C9—1 mf. bypass.
- C11—.0001 bypass.
- C12—.0005 bypass.
- C15—.005 bypass.
- C16—.5 bypass.

UTAH-CARTER

- R6—10 ohm rheostat. (UTAH-CARTER) midget.

KURZ-KASCH

- 1—4" dial for tuning condensers.

EBY

- 4—Four prong sockets.

IMP

- 2—Cord tips.

FROST

- 1—DX special sensitive head phones.

READRITE

- 1—0.3 model 55, zero adjustment. DC voltmeter.

MISCELLANEOUS

- 2—CS-3 shield cans for coils.
- 1—Formfitting grid cap tube shield for 1A4.
- 1—Formfitting shield for 30 tube.
- 8—Four prong SWF low loss coil forms.
- 1—Grid cap.
- 1—Midget short phone jack.
- 1—Twin jack for antenna and ground.
- 1—phone plug.
- 1—25 foot roll pushback hookup cable.
- 1—1/4 pound spool #28 DSC magnet wire.
- 1—1/4 pound spool #26 DSC magnet wire.
- 1—1/4 pound spool #24 DSC magnet wire.
- 1—1/4 pound spool #22 DSC magnet wire.
- 1—Piece 3/8" outside diameter bakelite tubing.
- 24—1/2" diameter plumbers soft rubber valve washers.
- 12—1/2" Insulating shoulder washers, 1/2" diameter shoulder.
- 2—1-1/2 volt A batteries.
- 3—45 volt B batteries.
- 2—4-1/2 volt C batteries.

HARDWARE

- 48—5/16" roundhead, 6-32 machine screws.
- 36—1/2" roundhead, 6-32 machine screws.
- 24—3/4" roundhead, 6-32 machine screws.
- 24—1" roundhead, 6-32 machine screws.
- 12—1 1/4" roundhead, 6-32 machine screws.
- 144—6-32 hex nuts.
- 6—Phone tips.

All screws and nuts to be of BRASS. NO IRON!



Look for those NEW ITEMS

It's easy to get the very latest condenser types. All you need do is look for the familiar yellow-and-black Aerovox cartons, and then spot those with bright red labels on front and sides (see above). Those labels denote new items. At a glance you can pick out the very latest things in condensers.

And then there's the Aerovox Catalog. Be sure you have a copy in your working library. It contains the most extensive choice of types, sizes, capacities, voltages, etc., and Aerovox is the one line on which you can standardize for ALL your condenser requirements.

Ask for Copy...

The local Aerovox jobber will gladly give you a copy of the new 1941 Edition. Also ask about free subscription to the monthly Research Worker. Or write us direct.



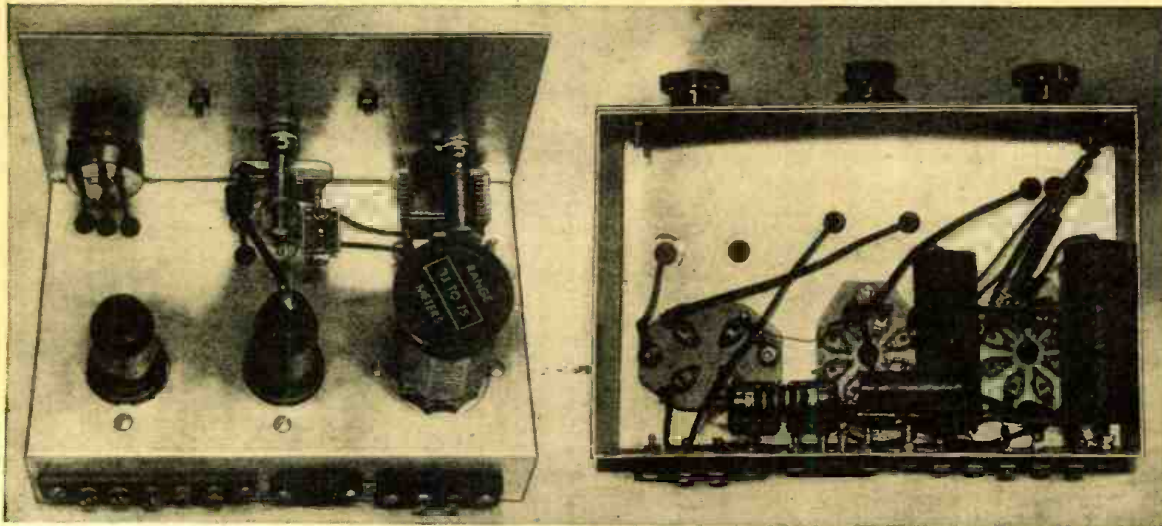

This two-tube receiver will appeal to the more advanced short-wave experimenter and the beginner as well. Strong signals will operate a speaker; the set may be operated from any power-supply.

Left—rear and bottom views of the two-tube receiver. Plug-in coils for the different bands give the set great flexibility.

Metal-Tube Two

● THE "Metal-Tube Two" receiver is for the more advanced short wave experimenter. Two of the newer metal tubes are employed. One is a 6J7 regenerative detector and the other, a 6C5 triode, is a resistance coupled audio amplifier. This combination provides about the ultimate in simple short wave receivers. It is especially sensitive and will produce extremely loud signals. Loud enough, in fact, to operate a small speaker.

Two hundred-fifty volts are required for the B-supply and 6.3 volts A.C. for the heaters.

In simple receivers the plug-in coil method is unquestionably the most satisfactory, because there is no danger of dead spots due to absorption caused by unused windings.

The tickler is connected in the plate circuit for obtaining regeneration. In the diagram, the tickler is shown at the top of the grid coil while actually it is wound at the bottom of the coil form. However, the connections remain identical. It is drawn at the top merely as a convenience. In order to eliminate feed back in the audio stage, and to keep all traces of R.F. out of the grid circuit of the audio amplifier, a filter consisting of a 2.1 mh. R.F. choke and two .0005 mf. condensers, is employed in the B-plus side of the tickler circuit.

Regeneration is controlled by varying the voltage applied to the screen grid of the

6J7 regenerative pentode detector. The 50,000 ohm potentiometer and the 100,000 ohm resistor, are connected in series across the B-supply, that is, between the B-plus and B-negative, in order to obtain the correct voltage for the screen grid.

The 30 mmf. trimmer, connected in series with the antenna, serves for varying the antenna coupling. Once set for the highest frequency coil, this condenser will need no further adjustment unless an extremely weak signal is encountered. Closing the condenser plates (increasing capacity), will increase the sensitivity and thus bring up the strength of the weak signal. However, as the capacity of this condenser is increased, the set automatically tunes broader. There is an optimum adjustment; one which provides sufficient signal strength without interference from stations transmitting on adjacent channels.

The diagram contains the circuit for an additional pentode power amplifier. This amplifier, when added to the main receiver will provide full speaker volume on all popular short wave stations. The .006 mf. condenser connected between the plate of the 6C5 and the B-minus should be connected between the plate of the 6F6 and B-minus when the additional audio stage is employed. The parts list does not contain the items employed in the additional amplifier. Also, the chassis on which the

original receiver is built is not large enough for the second amplifier. We suggest a 10" chassis—one extending 2" farther to the right. The drilling of the 8" portion will, of course, remain the same. The panel should also be correspondingly larger.

This receiver has been found to operate best on an antenna from 40 to 75 feet long. Consisting of a single wire, the antenna should be mounted in the clear and away from all trees, metal roofs, etc.

Parts List

HAMMARLUND

- 1—MC-140-M Band setting cond.
- 1—MC-20-S Band-spread cond.
- 1—MEX antenna trimmer (30 mmf.)
- 1—CH-X R.F. choke
- 1—S-4 socket
- 2—S-8 sockets
- 1—SWK-4, 17 to 270 meter plug-in coil set

CORNELL-DUBILIER

- 1—100 mmf. mica condenser
- 2—500 mmf. mica condensers
- 1—.006 mf. mica condenser
- 1—.1 mf. paper condenser
- 2—1 mf. paper condensers

I. R. C.

- 1—2 meg. ½ watt Resistor
- 2—¼ meg. ½ watt Resistors
- 1—2,000 ohm 1 watt Resistor
- 1—100,000 ohm 1 watt Resistor
- 1—50,000 ohm potentiometer

R. C. A.

- 1—6J7 metal tube
- 1—6C5 metal tube

MISCELLANEOUS

- 1—8 x 5 x 2" Chassis
- 1—8 x 6 x 1/16" Panel (aluminum)
- Terminal strips, screws, etc.
- 2—Knobs
- 1—Dial

—Courtesy Hammarlund Short Wave Manual

Chassis drilling dimensions.

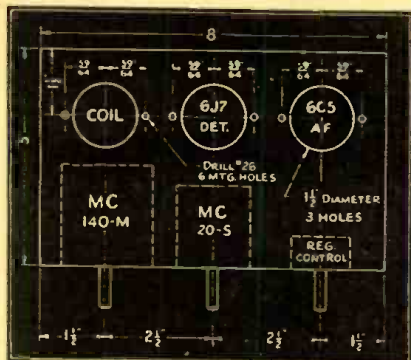

Hook-up for the "Metal-Tube Two" short wave receiver.

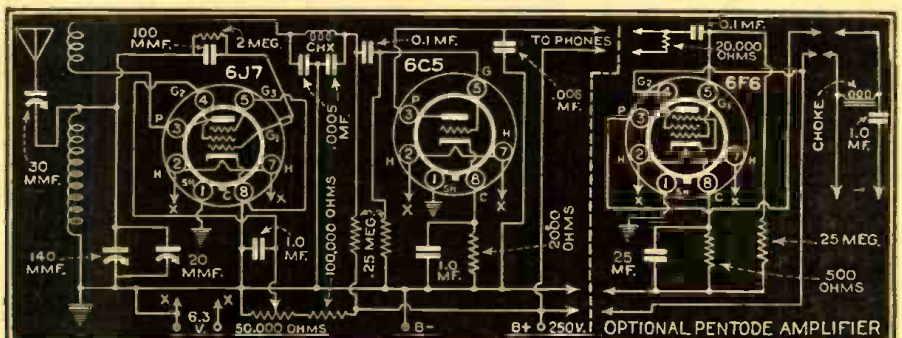



The high-quality amplifier designed and built especially for this article by Mr. Tait is here illustrated, and it has all the necessary controls required by modern practice.

The author's aim in designing this dual-purpose P.A. amplifier system was to build a low cost amplifier, with 8 to 10 watts output—coupled with excellent fidelity. The second objective was to build a versatile phonograph unit that could be used with or without the amplifier. This article, Part I, describes the amplifier; the second article will be devoted to the phonograph unit.

A Dual-Purpose

Public-Address System

Part I

Andrew Tait

● HERE is a complete P.A. system that experimenters can build at comparatively low cost. It is ideal for P.A. work at dances, for orchestras, and singing and all general "ballyhoo" work.

The P.A. system (to be described in part in this issue), was built with two objectives in view. The first was to build a low cost amplifier that has an 8 to 10 watt output, coupled with excellent fidelity. The second was to build a very versatile phonograph unit that could be used with or without the amplifier. This was accomplished by incorporating in the phonograph unit, a tuner, separate mike and phono channels and a wireless oscillator. These features combined in the phonograph unit mean

that this portable unit can be used with any radio set, absolutely independent of the amplifier. The construction of the phono unit will be described in a future issue of RADIO & TELEVISION magazine.

Amplifier

The amplifier was designed so as to be very simple to build. A template is shown that gives a very convenient layout of the component parts. It is resistance-coupled throughout. This enables one to obtain excellent fidelity and gain, without the use and expense of interstage transformers.

A 6J7 "high-gain" pentode stage is used as a microphone preamplifier. This has a high impedance input and will take almost

any level of high impedance microphone. Because of the high gain of this stage, hum may be picked up in both the plate and grid circuits; for this reason both circuits should be well shielded. A grid bias cell is used instead of cathode bias; this design insures "hum free" performance.

The microphone stage mixes into a 6SF5 along with the high impedance phonograph channel. The tone control "phono" and "mike" input jacks and associated gain controls are mounted conveniently on the amplifier chassis. There is also another input circuit, mixing into the grid of the 6SF5; this comes from the phonograph unit which will be discussed later. The gain control for this third channel is in the Phono Unit.

The picture at left shows loudspeakers on either side of the high fidelity amplifier; photo at right shows the amplifier in its case with ventilating louvres.

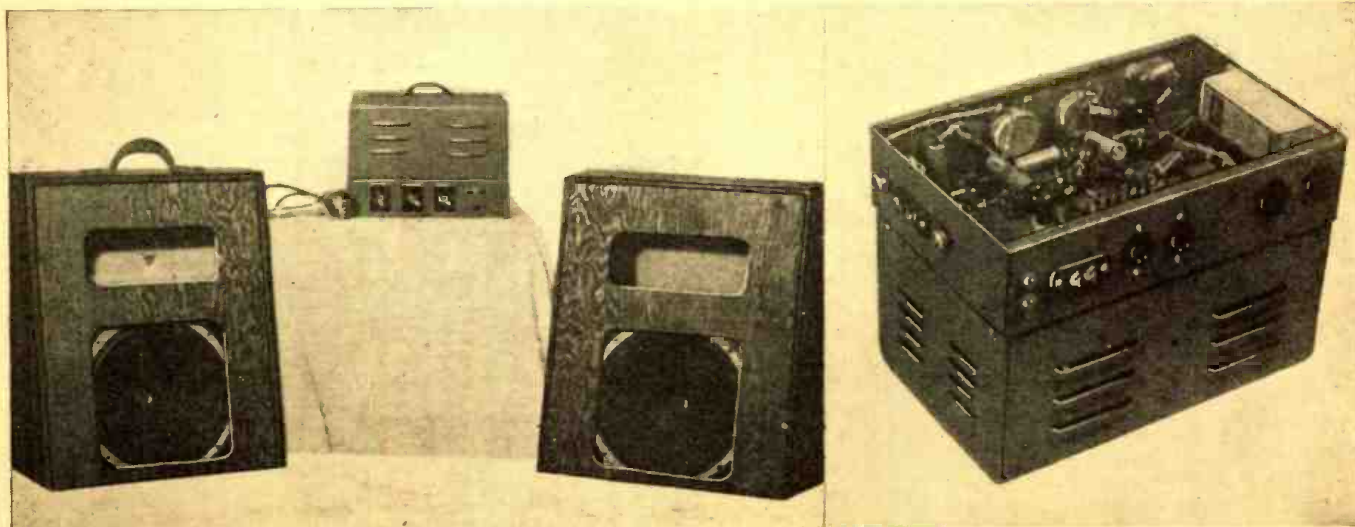

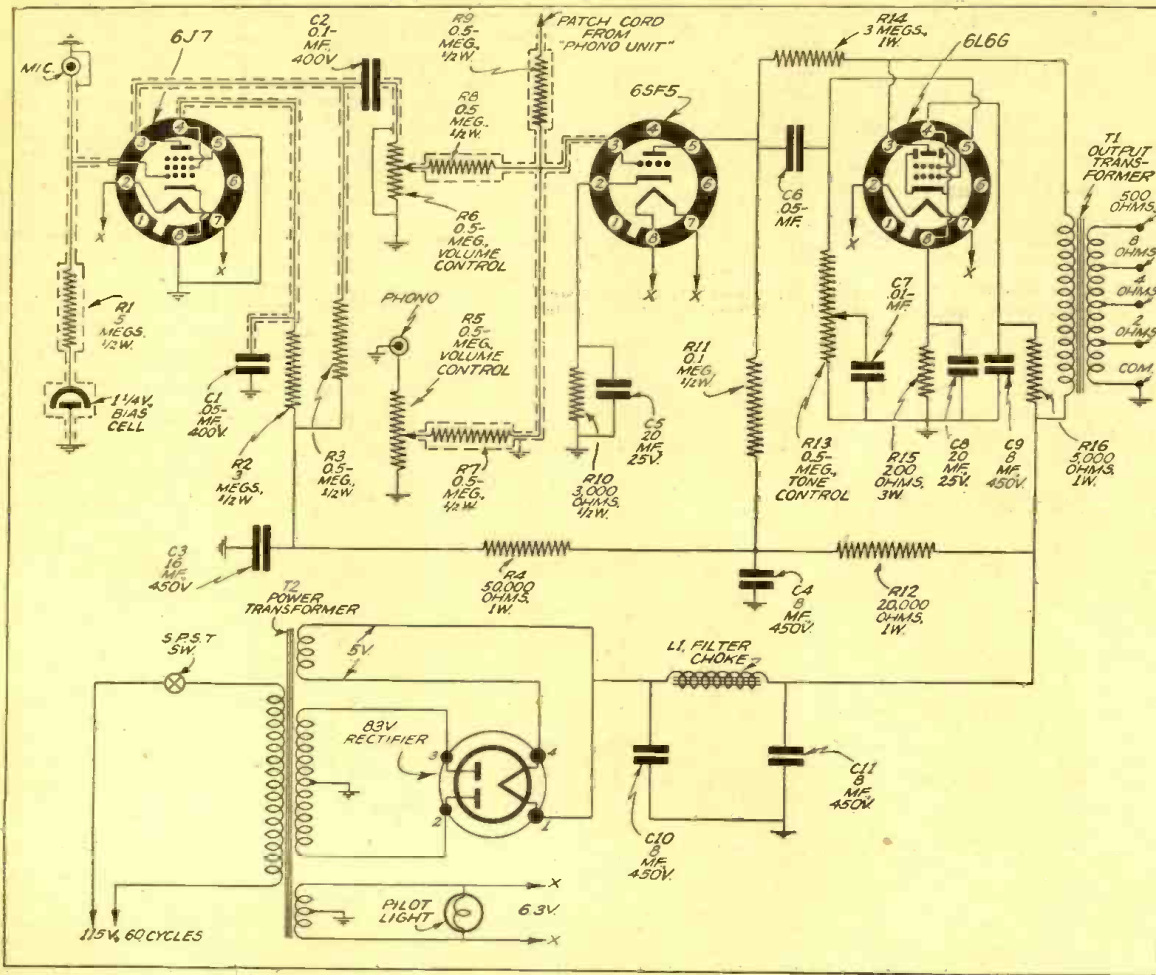

Wiring diagram of the 8 to 10 watt high fidelity amplifier, suitable for public-address work and also high fidelity phonograph reproduction.

These three channels can be mixed simultaneously, with absolutely no interaction. This is due to the 500,000 ohms in series with the volume controls that always keep the grid above ground.

This mixing stage is resistance-coupled to the final power output stage. A 6L6G beam power tube is used in this stage because of its high power sensitivity, high power output to relatively small inputs, and high efficiency. It has very low third and negligible higher harmonic distortion.

Feed-back: A very simple method of inverse feed-back is employed. A portion of the plate voltage (determined by the value of feed-back resistor R14), is tapped off the 6L6G plate and fed back to the grid. This feed-back voltage is 90 degrees out of phase with the input voltage and tends to cancel out any distortion generated in the plate circuit of the 6L6. This makes the distortion in the output circuit of the 6L6G comparatively low. The output is slightly lowered by this arrangement but may be brought up again by applying more driving voltage.

The Thordarson output transformer has taps at 2, 4, 8 and 500 ohms. These taps are brought out to two speaker plugs in parallel on the back of the amplifier, so that by selecting the proper terminals, the proper impedance values can be chosen for the speakers.

The 500 ohm line is also brought out to two banana plugs in the rear. This facilitates measurements on the amplifier under actual operating conditions. The 8 ohm tap is brought out to a terminal strip

marked "output." This is a convenience terminal for an auxiliary speaker.

Two 12" permanent magnet speakers are used that have voice coil impedances of 6 to 8 ohms. The speakers were designed to handle 10 to 15 watts. The speakers are each on 50 ft. rubber covered lamp cord. Thus the speakers may be taken and put in convenient places to get maximum coverage of a given location and also to prevent feed-back to the microphone. The speakers are connected in parallel across the 4-ohm tap on the output transformer. The loss in running the voice coil wires through that length of speaker cable is less than 1 db.

The speaker cabinets were built from one-half inch plywood with the Bass-Reflex design in mind. This design gives better bass response than that of a closed cabinet. The bass response approaches that of infinite baffles. The cabinet is cut diagonally through the center and the speakers set in so that it is an easy matter to carry them. The cabinets are fastened together with suitcase clasps and carried by the handle that is shown on top of one of them. The speaker inclosures are shown partially open so that the reader can see the construction to better advantage. The speakers are first mounted on a piece of sound-absorbing material such as Celotex, in which a hole is cut to fit the size of the speakers. The speaker, on the Celotex, is then mounted on the sounding board. The sounding board is placed in the cabinet and secured by screwing to corner blocks put there for that purpose. The Celotex baffles close up the leaks around the corners of the speaker

openings, thereby making the bass reflex chamber more efficient.

The cabinets were nailed and glued together, stained and shellacked. After rubbing down with steel wool, a final coat of varnish was put on them to give them a hard and lasting finish. Rubber feet help to keep the cabinets from becoming marred. All necessary dimensions are shown in the accompanying sketch. The final touch is to cover the speaker and bass reflex openings with a piece of grille cloth. Wire screening may also be used for this purpose but will result in a loss of high frequency response. With a little care in designing and building the speaker cabinets, not only will surprisingly excellent response result, but the cabinet will be a nice looking piece of furniture.

In the power supply an 83-V tube was used because of its excellent voltage regulation characteristics. This is due to the close spacing between the cathode and the plate.

Common procedures should be followed in building the amplifier. Filaments should be wired with leads twisted, to cut down the electro-magnetic fields around them, thereby reducing chances of hum pickup. All large parts, transformers, condensers, volume controls, etc., should be mounted first. Small parts such as paper condensers, resistors, etc., should be mounted where it is convenient and where they will cause the least interaction between circuits. As indicated in the diagram, certain circuits should be shielded. Resistors R7, R8, and R9 should first be insulated with spaghetti tubing before shielding. The backs of all

potentiometers should be shielded as well. These procedures if carefully followed will result in hum-free operation.

Make sure that tubes and speakers are in before turning the amplifier on. The input circuits can then be used in safety. A burned out output transformer may be the result of turning up the gain of any channel, without the speakers loading the output transformer.

The second part of this article will deal with the construction of the versatile phonograph unit, and will show results of frequency tests on speakers, microphone, pick-up and amplifier.

Parts List

INTERNATIONAL RESISTANCE CO.

- (Resistors)
 R1—5 meg., BT ½
 R2—3 meg., BT ½
 R3—500,000 ohms, BT ½
 R4—50,000 ohms, BT 1
 R5—500,000 ohms; type D; vol. control
 R6—500,000 ohms; type D; vol. control

- R7—500,000 ohms; BT ½
 R8—500,000 ohms, BT ½
 R9—500,000 ohms, BT ½
 R10—3,000 ohms, BT 1
 R11—100,000 ohms, BT ½
 R12—20,000 ohms, BT 1
 R13—500,000 ohms; type D; tone control
 R14—3 meg., BT 1
 R15—200 ohms, 3 W
 R16—5,000 ohms, BT 1

BUD RADIO, INC.

- 1—S.P.S.T. toggle switch, #SW1003
 3—K17A, red vol. control knobs
 1—JL-1692F, red jewelled pilot
 1—#DP-978, "Record" dial plate
 1—#DP-979, "Microphone" dial plate
 1—#DP-981, "Tone" dial plate
 1—#DP-1180, "Mike" jack name plate
 1—#DP-1181 "Phono" jack name plate

THORDARSON ELEC. MFG. CO.

- (Transformers)
 T1—Output transformer, T-17S10
 T2—Power transformer, T-13R07
 L1—Filter choke, 17C00B

RCA (Tubes)

- 1—6I7
 1—6SF5
 1—6L6G
 1—83V

AMPHENOL

- 2—#CL-PC1M mike connectors
 2—#61-F A.C. receptacles
 3—Type S-8 tube sockets
 1—Type S-4 tube socket
 2—Type S-5 sockets for speaker plugs
 2—Type PM-5 plugs for speaker cord

INSULINE CORP. OF AMERICA

- 1—Amplifier chassis, 8" x 12" x 9", #3972, with bottom plate
 2—2 terminal, terminal strips, #2417 (input), #2418 (output)

CORNELL-DUBILIER ELEC. CORP.

- C1—.05 mf., paper, 400 V.
 C2—.1 mf., paper, 400 V.
 C3—16 mf., KR-516, 450 V.
 C5—20 mf., 25 V., Blue Beaver
 C6—.05 mf., paper
 C7—.01 mf., paper
 C8—20 mf., 25 V., Blue Beaver
 C9, C4—Dual 8-8 mf., 450 V., EB8800
 C10, C11—Dual 8-8 mf., 450 V., EH9808

UTAH (Speakers)

- 2—12" dia., 10-15 watt, 6-8 ohm, voice coil impedance

SHURE (Microphone)

- "Ultra" Rocket 705A

Details of the chassis and dimensions of the loudspeaker cabinet are given in the drawing herewith.

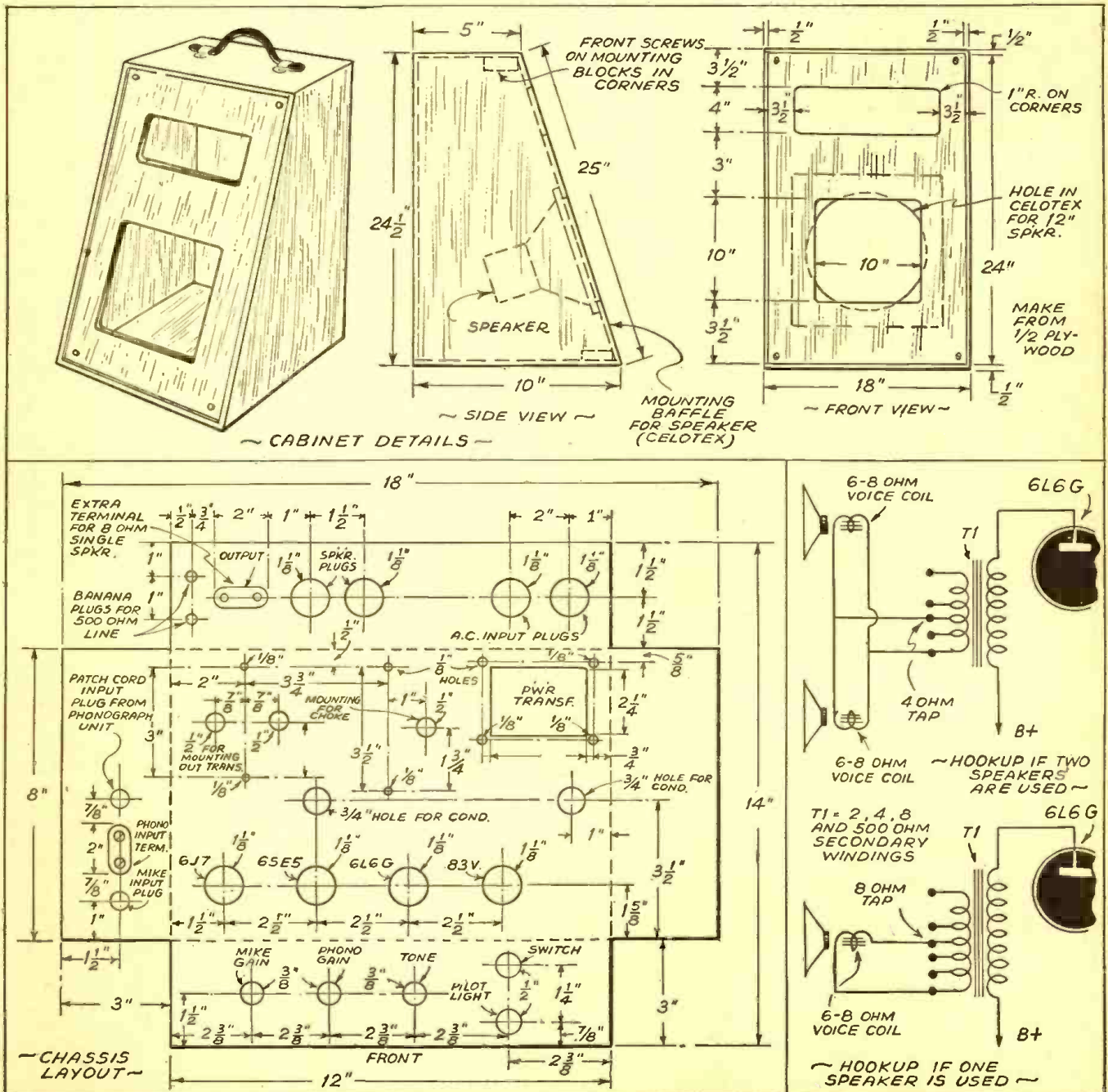

Your First Short Wave Set

How to Build It

By William J. Vette

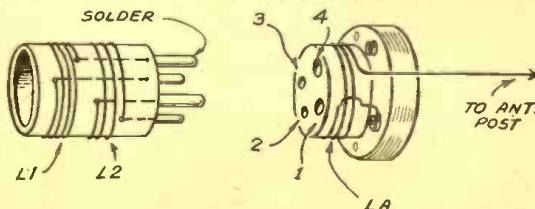
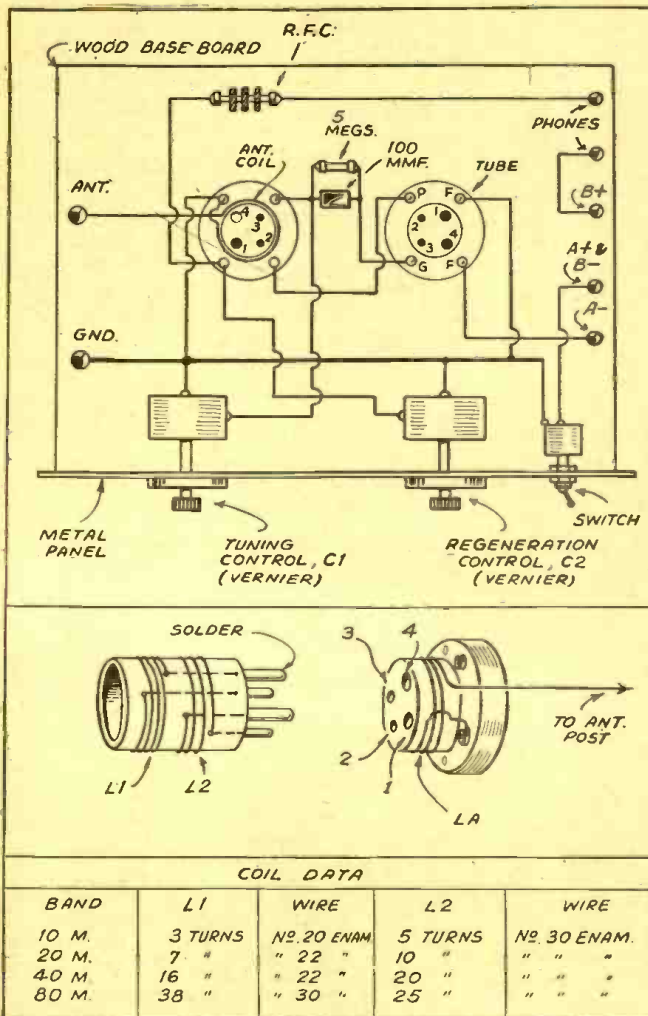

COIL DATA

BAND	L1	WIRE	L2	WIRE
10 M.	3 TURNS	No. 20 ENAM.	5 TURNS	No. 30 ENAM.
20 M.	7 "	" 22 "	10 "	" " "
40 M.	16 "	" 22 "	20 "	" " "
80 M.	38 "	" 30 "	25 "	" " "

The construction of this Beginner's short-wave receiver is apparent from the illustrations herewith. The set may be wired with bell or other wire, and all the parts can be picked up at low cost in the radio shops. A pair of 2,000 ohm or higher impedance headphones will ensure good long distance reception. The knack of tuning the set is soon mastered.

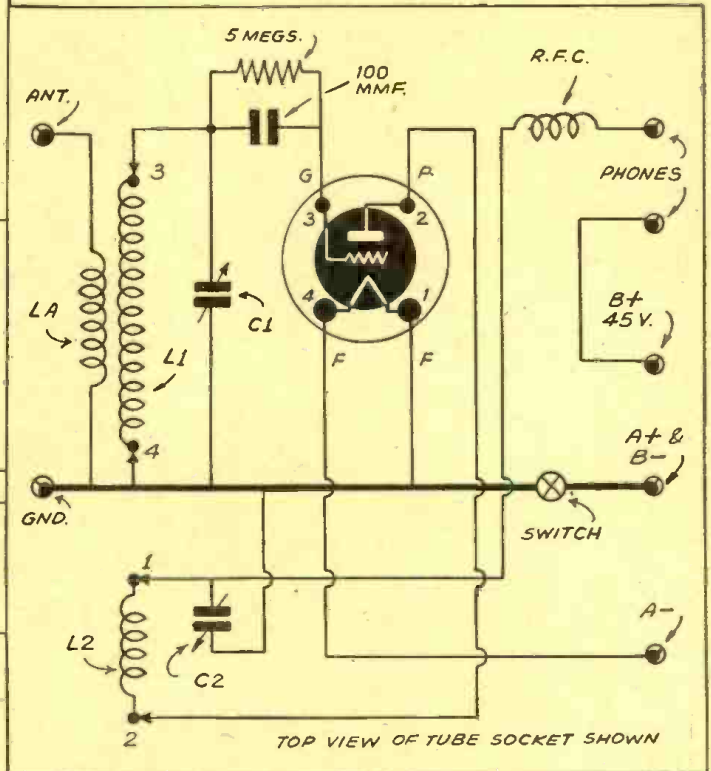

● A REALLY fine short wave radio which will bring in hundreds of distant stations with good volume may be built at little or no cost by any beginner.

The original model of this set, built many years ago by the author (this was MY first short wave set!) was built around a 201A tube, with storage battery for the filament supply; in this instance, you may use any standard three element tube you have handy, such as the 30, 99, 01A, etc., depending on which is easiest obtainable, and also on what you have handy in the way of filament supply. If you must purchase both tube and batteries new, I would recommend either the 30 tube, with its filament supply of 2 volts, or the more modern 1G4-G, which only requires 1.4 volts, easily obtainable from a single ordinary dry cell, or even from a little flashlight battery. However, in the event that any of the 1.4 volt tubes are to be used, it will be necessary for the builder to substitute an eight-prong octal socket for the tube, in the place of the four-prong socket shown in the drawings and picture diagrams.

Before starting any of the actual con-

struction work, the builder should obtain all of the necessary parts, to aid in laying out the set. A metal panel, which may be a sheet of aluminum, of about 16 gauge, will serve well for the front panel; an ingenious constructor will find a suitable substitute which will meet the desired qualifications. The baseboard is of wood.

The condensers, if of the midget variety, will probably mount directly on the front panel; if the larger, cut down type is used, some will mount to the front panel by two or three screws, and others will have to be mounted to the baseboard by means of mounting feet. In either case, this point in the assembly is the point where the panel should be fastened to the baseboard, by means of three or four woodscrews along the bottom, into the edge of the baseboard. Mount also the switch, thru the panel, in the lower right hand corner, near the battery binding posts. Lay out the other parts shown in the picture diagram as shown, so as to allow all leads to be as short and direct as possible. Do not mount the coil socket permanently as yet, for we have to wind

the antenna coil on it a little further on before we do.

The dial for tuning the set should have a vernier/or reduction action, and should work very smoothly. A similar dial is helpful, but not absolutely necessary, on the regeneration control condenser. An ordinary knob of large diameter may be used here in the interest of economy.

The socket needed is that which mounts flat on a wooden subbase, with the portion carrying the contacts projecting up from the flat part. Such a socket is absolutely necessary for the coil, as we use the projecting part for a form for the antenna coil, and such a socket for the tube simplifies its installation.

The coil socket should be prepared before fastening to the base by winding 3 turns of No. 20 enamel or cotton covered wire around the top, as shown in Fig. 4. Wind in the direction shown in the drawing, leaving the bottom of the winding free for connection to the antenna binding post. Fasten the top of the winding to terminal 4, the negative filament terminal, of the socket, by soldering.

The bases of old tubes having four prongs are used for the coil forms. Clean out the cement on the inside of these bases, after removing the glass and the tube elements. With a hot soldering iron, melt the solder at the ends of the prongs and remove the wires inside these prongs, leaving the prongs clear for the passage of your coil wires. Wind your coils exactly according to Fig. 3. Be especially sure to carefully make your connections to the proper prongs as shown; if care is exercised here in following these directions, no trouble, such as the set refusing to oscillate, will be experienced. The wire specified for the coils is especially chosen for its easy availability; such wire may be reclaimed from old buzzers, magnet coils, etc.

The Radio Frequency Choke specified is one item that should be purchased new, as it is inexpensive, easy to get, and dependable, whereas one made by the constructor might have faults which would cause deadspots in the tuning range of the receiver.

The binding posts for connection to the antenna, ground, batteries and headphones may be any good binding posts you can find, although the easiest to use in this style of construction work are the old Fahnestock clips, which may be salvaged from old "B" batteries, or may be bought new. These clips are easy to mount to the wooden base by means of small wood-screws.

Assuming you have obtained all of the parts needed, made the necessary alterations to those parts requiring alterations, and have all your parts laid out and mounted as advised, you are ready to start the actual wiring of the set.

Wiring the Set

Connections from one part to the other should be made with a good grade of hook-up wire; the type on which the insulation pushes back is the easiest to use, and is quite inexpensive. At any rate, the wire used for hooking up the set should be well insulated and tinned for easy soldering, without the use of any additional flux or paste. Soldering of each joint should be done with only a good grade of radio, or rosin core, solder. Your soldering iron, preferably electric, should be clean and well tinned, and should be just hot enough to cause the solder to flow quickly; never allow your iron to become too hot, as the tip will corrode and burn, and soldering will be quite difficult. With a well tinned iron at just the right temperature, soldering is quite an easy job.

We will wire the filament circuit first; this is a good procedure to follow in building any set.

Run a length of wire from the A-binding post to the terminal on the tube socket marked "F-"; looking at the top of the socket, with the large prongs at the bottom, this is the large prong to the left. The other large prong on this socket is connected to the "F-" prong on the coil socket, to one side of the switch, to the rotating plates of both condensers, and to the ground binding post. The other side of the switch goes to the "+A-B" binding post.

Connect the 5 megohm grid-leak across the terminals of the 100 mmf. (.0001 mf.) grid condenser. One connection of this assembly is connected to the "G" prong of the tube socket, the other end going to the same terminal of the coil socket. This terminal, "G", on the coil socket, also connects to the stationary plate of the tuning condenser. Your filament and grid circuits are now wired, and you are ready for the plate circuit.

Terminal "P" on the tube socket connects to the same terminal on the coil socket. Now the only remaining terminal on the coil socket, the "F+" prong, is connected to one side of the RF Choke, and also to the Stationary plate of the regeneration condenser. The opposite side

of the RF choke goes to one headphone binding post. The other headphone post goes to the "B+" binding post.

Connect the free end of the antenna coil, wound about the coil socket, to the antenna post, if you have not already done so.

If the tuning condensers are not the type which mount directly on the front panel, you should run a lead from the ground post to the panel, connecting it under one of the screws with which you fastened the panel to the base. This grounds the panel, so it will act as a shield, otherwise, the nearness of your hand to the set would detune it, making tuning very difficult.

GET RID OF CIGAR BOX CONFUSION!

**HAVE THE RESISTOR YOU WANT
RIGHT AT YOUR FINGER TIPS**



FREE!... THE IRC RESIST-O-CABINET

Here's an end to cigar boxes, tin cans, jars and other unsatisfactory make-shift methods of keeping resistors. The IRC Resist-O-Cabinet is specifically designed to hold resistors systematically and safely without bending of leads. It gives you a compact resistor "department" that puts any wanted resistor right at your finger tips and gives you a visual inventory of your resistor stock in a split second. Best of all . . . it's yours without one penny extra cost . . . with any of three factory-packed IRC Resistor assortments.

IRC Type BT Metallized have won acknowledged leadership in every mechanical and electrical characteristic. They're always dependable—they stay put. 1/2-, 1- and 2-watt sizes in all ranges. Insist on IRC's and be sure to get the FREE Resist-O-Cabinet! Your jobber has yours ready.

INTERNATIONAL RESISTANCE CO.
401 North Broad Street Philadelphia, Pa.

INSULATED Metallized RESISTORS

WIRELESS TRANSCASTER

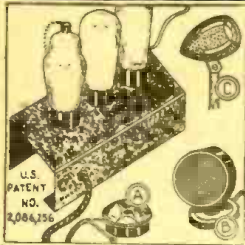

HUNDREDS

of Practical applications. Will broadcast voice or music from any room or floor in home, office or store in same building WITHOUT CONNECTING WIRES! Operate from any lighting socket. Transmit your favorite recordings thru any radio without connections between radio and phonograph. Your radio becomes a public address or inter-communication system with a Transcaster.

Home broadcasting without wires. Great fun for parties, auditions. Use as a detective device to listen to secret conversations. A few other uses include wireless nursemaid, piano tracer, mind reader, trick ventriloquist, bingo announcer, talking dog, etc. Impossible to enumerate many other uses in this limited space.

TRANSCASTERS are available in FIVE models, all completely wired, laboratory tested and ready to use. All fully guaranteed as to materials and workmanship and also against damage in transit.

STANDARD MODEL Excellent beginner's outfit. Permits use of earphone or small max. speaker or microphone, or any high impedance magnetic or crystal pickup record player. POWERFUL, not to be confused with one tube type outfits. Priced amazingly low. Works from a.c. or d.c. Price, complete with 3 tubes, ready to use (less mike) **\$2.95**
Earphone Mike (Fig. A)95c additional

SENIOR MODEL All electric. Can be used with all types of power mikes. Extra amplification of 50 db. provided. Adjustable frequency range between 1500 and 1750 kc. or if preferred between 500 and 800 kc. Price (less tubes and mike) **\$3.50**
Set of 4 matched Tubes for Senior Model\$1.45

DE LUXE MODEL TRANSCASTER-TRANSMITTER Powerful, high-gain device engineered so that it will transmit high-fidelity music without connection wires to remote radio set. No sacrifice of quality or power. Operates from a.c. or d.c. Same frequency range as Senior model, but greater db. amplification. Price (less tubes and mike) **\$4.95**
Set of 4 Matched Tubes for DeLuxe Model\$1.95

SPECIAL 5-TUBE TRANSCASTER This ultra-advance has been engineered especially for efficient experimental and professional uses. Employs two extremely high-gain pre-amplifier stages ahead of the audio modulated oscillator. When used with crystal microphone it will pick up and transmit a whisper with mike concealed anywhere in room. Suitable for special police work, for use with recorder, etc. Price, complete with 5 tubes, ready to plug into any a.c. or d.c. outlet (less mike) **\$15.00**

SPECIAL 3-TUBE BATT. OPERATED TRANSCASTER Uses newest miniature type vacuum tubes. Many professional uses. Camera size, compact and light. Price, complete with tubes and batteries (less mike) **\$20.00**

TRANSCASTER ACCESSORIES Dynamic Microphone, 50 db. (Fig. B) \$1.95; 825 1st. Wide Range Response Crystal Mike (Fig. C) \$3.95; High Impedance Crystal Pickup \$2.45.

TELEJECTOR

RADIO'S MOST AMAZING ACCESSORY

Picks up telephone conversations without tapping wires. Merely place device near telephone instrument or wire and listen to both sides of any telephone conversation through the loud speaker of your radio. Works from any a.c. or d.c. outlet. Complete with tubes, ready to use **\$7.90**

LAST MINUTE BARGAINS FOR BOYS FROM 9 TO 14

30-pc. Radio Exper. Kit includes R.C.A. Tube \$1.00
1-Tube Broadcast Kit (bat. op.) with tube 1.00
1-Tube Short Wave Kit (bat. op.) with tube 1.50
2-Tube Elec. Transmitter Kit with tubes 2.50
3-Tube Bat. S.W. Kit with 4 coils and tubes 3.45
3-Tube Elec. S.W. Kit with 4 coils and tubes 4.25

FOR YOUNG MEN

5-Tube Senior Space Explorer Kit, Beam Power, All-Electric, metal tubes, dyn. spkr. 6 coils **\$15.35**
6-Tube 7-Band Communications Kit with tubes and all accessories Model 75 **17.45**
Electronic Capacity-Actuated Alarm Relay. Ready to operate from 110 Volts A.C. or D.C. **8.90**
Code Practice Oscillator with 2 Tubes Ready to operate from 110 Volts A.C. or D.C. **3.95**
3-Tube S.W. Set wired & tested, ready to use including coils from 912 to 550 meters and 3 tubes (less earphone) **6.50**

H. G. CISIN, Chief Engineer

ALLIED ENGINEERING INSTITUTE

Dept. S-79

85 Warren St., New York, N. Y.

Check Connections Carefully
With the coils all wound, and the wiring completed, the set is ready for test. Check all of your connections carefully against the picture diagram, to be sure you have made all connections correctly. If it checks out all OK, connect up the batteries and headphones to the proper binding posts, hook up your aerial to the antenna post and we're ready to go. Be sure you have the right batteries, properly connected. The "A" battery, of a voltage suited to the tube you are using, is connected to the posts marked "A" and "Plus A-B". You will note that the positive side of the A battery and the negative side of the B battery connect to the same post. The positive side of the B battery goes to the B post connected to the headphone post. Be very careful in connecting your batteries, for a mistake here might cause you to burn out your tube.

Ready for Test!

Insert one of the coils, let's say the 40 meter coil, into the coil socket. Turn the switch so the tube lights faintly. Swing the regeneration condenser back and forth to see if the set oscillates. If so, a point will be found on the dial of this condenser where the set makes a gentle "plop" and makes a soft, rushing noise on one side of this point. (It may be necessary to reverse the connections to the tickler to make the set work properly.) When this point is found, you may turn the tuning dial back and forth in search of a signal. The presence of a signal is told by a whistle in the phones, which varies up and down in tone as the dial is moved back and forth. Tune to the exact center of this whistle; i.e., to the point where the whistle has dropped clear down in tone and is starting up again, and then back off the regeneration condenser until the point is found where the whistle just barely stops. This is the point where the station will be strongest, unless you are listening to code stations, in which case you must let the set oscillate a little bit, to make the signal audible. Now tuning over the band provided by each of the coils should bring in any number of stations, both code and broadcast, and amateur stations aplenty.

The values of coil and condenser are chosen to give a maximum spreading effect to all bands tuned, without the added complication of extra band-setting condensers, or the expense of the same. With these values, more coils are needed to cover a given range, but efficiency in general is much better overall, as there is less capacity across the coils than is the case with larger condensers of wider range.

If every connection has been carefully made as shown and directed, the set should operate at once, and no trouble should be experienced. Be especially careful to wind and connect your coils exactly as shown, as most troubles experienced by beginners are traceable to wrong coil connections.

Just because this set is so simple and inexpensive to build, don't get the idea that it won't perform. As mentioned before, this identical circuit was used in the first short wave set ever built by the author, way back when short wave sta-

tions were a lot weaker and more unreliable than they are today, but I can still well remember the thrills I had tuning in Europe and South America with that little set—and the greatest thrill it produced came real early one Sunday morning, when it tuned in VK2ME, Sydney, Australia, half way around the world.

Parts List for SW Receiver

- 1—Panel, see text
- 1—Baseboard
- 2—Variable condensers, 15 minf. (.000015 mf.) see text for details
- 1—Grid-leak, ½ watt, 5 megohms
- 1—Mica grid condenser, .0001 mf.
- 2—Four-prong sockets for wood base mounting
- 1—2.5 mh. R.F. choke, pie-wound, as National, etc.
- 7—Binding posts or Fahnestock clips
- 1—Switch, S.P.S.T.
(Tuning and regeneration dials as explained in text)
- 1—Pair headphones, 2000 ohms (or higher)
- 1—Tube, see text
- 1—"B" battery, 45 volts. (22½ volts will work well, but the 45 volt battery will give slightly more volume. If you have a 22½ V. battery, use it.)
- 1—"A" battery, according to tube
(Hook-up wire, screws for mounting parts, etc.)

ALL AMATEURS CAN NOW USE PHONE!

GOOD news for the 57,000 odd licensed radio amateurs in the United States came in the form of a new ruling from the Federal Communications Commission on July 23rd, which among other things, opened up the 40 meter amateur band to phone transmission. Further, about 35,000 amateurs who were restricted from using phone, due to their holding Class B or C licenses, are now permitted to use phone.

The amateur bands now open to phone transmission are the 160, 80, 40, 20 and 10 meter bands.

One of the reasons for opening up the greater facilities for phone transmission by amateurs was the F.C.C.'s partial restriction on amateur phone in the 80 meter band. During the emergency conditions, the F.C.C. has ruled that beginning about September 1st, amateurs will have to move out of that portion of the 80 meter band lying between 3800 and 3900 kc. About January 1st 1942, the amateurs will similarly be asked to vacate those frequencies lying between 3900 to 3950 kc. and 3750 to 3800 kc. Further, about March 15, 1942 that part of the band lying between 3650 and 3750 kc. is to be vacated by amateurs. With these changes, the remaining part of the 80 meter band width will still be available for phone and CW.

The F.C.C.'s reason for making this curtailment in the 80 meter band, is that part of this band is urgently needed for pilot instruction at U. S. flight training fields.

In the (7 mc.) 40 meter band a section 50 kc. wide has been opened to phone.

This fall should see great activity in amateur phone station construction, with the phone now made available to about 35,000 amateurs who heretofore had to confine their activities to CW (code).

Phone is now authorized also on the 10 meter band from 28,100 to 30,000 kc. instead of 28,500 to 30,000 kc. as heretofore, a gain of 400 kc. width. A band width of 50 kc. for a amateur FREQUENCY MODULATION transmission has also been granted, the frequency limits being between 29,250 to 30,000 kc.

The Editors Want

articles on new radio facsimile and television sets.

Construction data with diagrams and photos urgently needed.

Articles wanted on construction of receivers and transmitters for operation on 120 and 240 mc.

Also articles on simple test "set-ups," facsimile, etc.

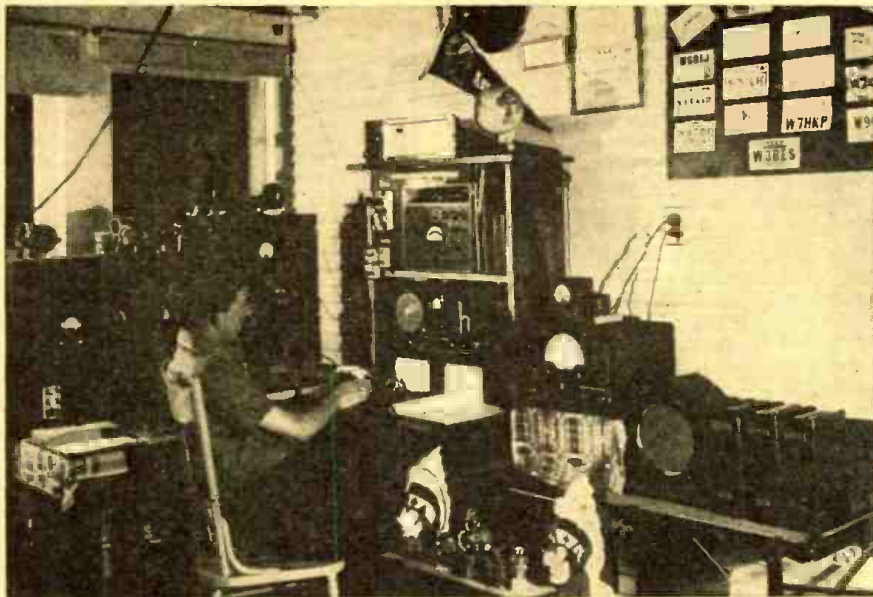

"Honor" Plaque Awarded
To Bruce C. Vaughn, Jr., W5HTX
For Best HAM Station Photo

• TO the best of my knowledge "Radio & Television" magazine is responsible for my being a Ham. A friend gave me a few copies and my "Radio Fever" hit an "all-time" high! I have been a reader of your magazine ever since.

I will be more than glad to QSL with any SWL or Ham. The main transmitter here is a 6L6G xtal-P.P., 45's Buffer-P.P. T40's. Runs 150 watts. The small transmitter on the floor uses a 2A5 Xtal Osc-P.P. 2A3's final; runs 25 watts.

The antenna is a half-wave Zepp. Two receivers are used here, a Breting 9 and a Sky-Buddy S-19R. The Breting has a home built "R" meter attached.

The only band worked is 40 meters. W5HTX has been on the air for about two years and a half and has worked 45 states, Canada, Hawaii, Puerto Rico, Cuba and Australia. Over 2500 contacts on 40 meters have been made.—Bruce C. Vaughn, Jr., W5HTX, Springdale, Arkansas.

Here is the new "Award of Honor" Plaque which measures 5"x7" in size. It is handsomely executed in colors on metal, and is framed, ready to hang on the wall. The name of the winner will be suitably inscribed.

Note These Important Rules

Attach a brief description not longer than 300 words, describing the general line-up of the apparatus employed, the size, type and number of tubes, the type of circuit used, name of commercial transmitter—if not home-made, watts rating of the station, whether for c.w. or phone or both, etc., also name of receiver.

State briefly the number of continents worked, the total number of stations logged or contacted, and other features of general interest. Mention the type of aerial system and what type of break-in relay system, if any.

Important—Enclose a good photograph of yourself, if your likeness does not appear in the picture!

You do not have to be a reader of RADIO & TELEVISION in order to enter the contest.

Address all photos and station descriptions to Editor, Ham Station Photo Contest, c/o RADIO & TELEVISION, 20 Vesey Street, New York, N. Y.



NEW
HAMMARLUND
SHORT WAVE
MANUAL

JUST OFF THE PRESS

- TRANSMITTERS**
- EXCITERS**
- RECEIVERS**
- POWER SUPPLIES**
- ANTENNAS**
- MODULATORS**

EVERYTHING for the Amateur and the Experimenter will be found in this valuable little book. Its 32 pages are crammed with valuable information on constructing and operating short-wave transmitting and receiving apparatus. Written in simple language, the new Short Wave Manual will appeal to the beginner and old-timer alike. If your dealer doesn't have the new manual in stock, send coupon below, with ten cents (coin or stamps) to cover mailing and your copy will be sent by return mail.

GET YOUR COPY TODAY!

HAMMARLUND MFG. CO., Inc. RT-9
 424 W. 33 St., N. Y. City

Enclosed find 10c to cover mailing costs of manual.

Name

Address

City State



HAMMARLUND

Canadian Office: 41 West Ave. No., Hamilton, Ont.

Fixed Condensers in Radio Transmitters

● **FIXED** condensers are among the simplest of radio circuit components. Their basic construction is substantially the same as that of the 18th century Leyden jar, forerunner of all condensers. The manner

common disorders may be "designed out" of a transmitter in the beginning by properly selecting its fixed condensers.

In this article, we will endeavor to give practical rules whereby the proper fixed

R.F. voltages to which the condenser is subjected and upon the operating frequency. The functions of the various capacitors will be discussed first, and then the factors governing their characteristics will be presented.

Bypass Condensers

From the simplest viewpoint, the purpose of a bypass condenser is to *detour* R.F. or A.F. currents around a circuit or sub-circuit through which they must not flow, or in which they might encounter a large amount of resistance or impedance. In practice, such a circuit generally carries a D.C. component. Bypassing action is obtained through the ability of the condenser to block completely the D.C. component, while providing a comparatively low-impedance path for the alternating currents.

The commonest bypass capacitor is probably the cathode condenser, such as C_1 in Figure 1, which acts to conduct the A.C. component of tube plate current around the cathode bias resistor to ground. Since this condenser is to provide a low-impedance path for an alternating current, its capacitance must be such that its reactance will be low at the A.C. frequency. Reactance varies inversely with frequency, therefore low-capacity condensers will be most suitable for bypassing R.F. circuits in a transmitter; high-capacity ones for A.F. circuits—in which an audio component appears.

Very high voltages are not usually encountered in tube cathode circuits, so the D.C. operating voltage rating of the cathode bypass condenser need not be so high as that of other bypass condensers associated with the high-voltage plate and screen circuits. But the cathode bypass condenser must be capable of carrying the R.F. or A.F. current which would normally flow through a condenser of its capacitance in the tube cathode circuit at the operating frequency. Manufacturers' rating tables list the maximum safe R.F. current for definite condenser types at various common operating frequencies. The actual current through the condenser may be measured under operating conditions by one of two methods: by inserting a thermoammeter of suitable sensitivity in series with the condenser, or by reading the A.C. voltage appearing across the condenser with an isolated vacuum-tube voltmeter and calculating the current therefrom by Ohm's Law for A.C.

Note that plate voltage, E_1 , and grid voltage, E_2 , act in series against coupling condenser, C .

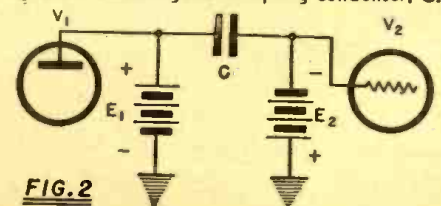

FIG. 2

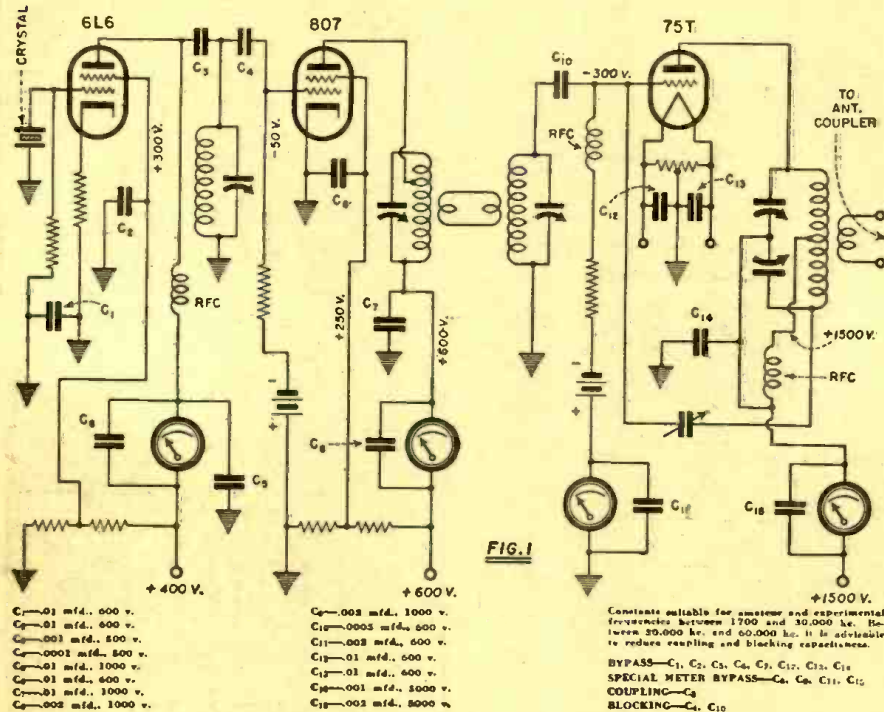

FIG. 1

Constants suitable for amateur and experimental frequencies between 1700 and 30,000 kc. Between 30,000 kc. and 60,000 kc. it is advisable to reduce coupling and blocking capacitance.

BYPASS— $C_1, C_2, C_3, C_4, C_7, C_{12}, C_{13}, C_{14}$
SPECIAL METER BYPASS— C_5, C_6, C_{11}, C_{15}
COUPLING— C_8
BLOCKING— C_9, C_{10}

This diagram shows a typical amateur or experimental transmitter of 200 watts output—CW or phone.

in which they operate is easy to understand. But despite their freedom from complexity, fixed condensers perform numerous essential functions and are, as a result, liberally distributed throughout receiver and transmitter circuits.

In transmitter R.F. stages, and between these stages, fixed condensers serve the important purposes of bypassing, coupling, and blocking. They make possible the transfer of radio-frequency energy between circuit points, the removal of R.F. currents from certain parts of a circuit, and the separation of A.C. and D.C. components. Thus, the fixed condenser plays a trilateral role in the complicated process of transforming commercial A.C. power into radio waves.

Fixed condensers for transmitter R.F. circuits must be judiciously chosen with respect to *capacitance, voltage rating, current rating, dielectric, type of construction, casing, circuit function, and operating frequency* to insure efficient and economical transmitter operation. Many of the operative difficulties, such as parasitic oscillations, reduced excitation voltage and R.F. leakage, which arise in transmitter circuits may be traced to neglect of one or more of these items. Hence, it is apparent that numerous

transmitting capacitor may be selected for each circuit position. And while concentration will be in the direction of the R.F. portion of the transmitter, we have not forgotten that fixed condensers play an important part in the audio-modulator channel. However, the rules for radio-frequency applications, as outlined, will apply with very slight modification to the A.F. stages as well, since the lone difference encountered is the reduced frequency of operation.

Figure 1 shows a conventional three-stage transmitter circuit such as might be employed on amateur, commercial, and experimental frequencies between 1500 and 30,000 kc. This arrangement, using a single 75T tube in the output amplifier, is capable of delivering 200 watts of modulated or unmodulated R.F. power to a suitable antenna. There are fifteen separate fixed condensers in this circuit, acting to bypass R.F. currents, transfer R.F. energy from one stage to another, or to prevent the passage of direct currents. Each of these condensers is, in general, subject to different operating voltages, and the capacitance of each will be determined by its special purpose and the frequencies which it must pass. The minimum voltage and current rating of each will depend upon the maximum D.C. and

The tube-screen condenser, such as C_2 and C_3 (Figure 1), is another well-known type of by-pass capacitor. This condenser places the screen electrode effectively at ground R.F. potential and must be capable of operating safely at the D.C. screen voltage. Like the cathode condenser, the screen capacitor must have low reactance at the operating frequency. The tube manufacturer usually specifies the value of capacitance which is most effective with a particular type of tetrode, pentode, or beam power transmitting tube.

The plate-circuit bypass condenser (C_5 , C_7 , and C_{11} in Figure 1) connects the tuned circuit, or "plate tank," to the tube cathode, with respect to R.F. currents. Thus, it provides a radio-frequency return circuit from plate tank to cathode without short-circuiting the high-level D.C. plate voltage to ground. Good plate bypass condensers are essential to proper operation of a radio-frequency transmitter stage.

Plate bypass condensers should be rated to operate at twice the D.C. voltage that will be applied to them by the plate-circuit power supply in a telegraph transmitter, and 4 times the D.C. voltage when they are employed in the modulated stage of a radio-telephone transmitter. Their actual capacitance should afford low reactance at the transmitter frequency, or the frequency of the stage in which they are inserted.

Although leakage has not much effect on bypassing efficiency, a good grade mica condenser will be superior to paper types in cathode, screen, and plate applications. The tubular type condensers should be particu-

9, Cherry Orc.-
LICHFIELD,
Staffs.
24th May, 1941.

Dear Sirs,

I would like to place on record my appreciation of a most pleasant transaction and add that I am delighted with the Receiver. During the last eight years I have owned various models of well known Communications Receivers, but not one has come anywhere near to bad, some good, but not one has come anywhere near to the H.R.O. in performance.

The money spent during this period would have bought several H.R.O. Receivers and it is only when one has used an H.R.O. Receiver and it is only something good and cheap, it simply does not exist. The H.R.O. is worth every penny spent and is first class value.

Yours faithfully,
(signed) JOHN M. FOGGO

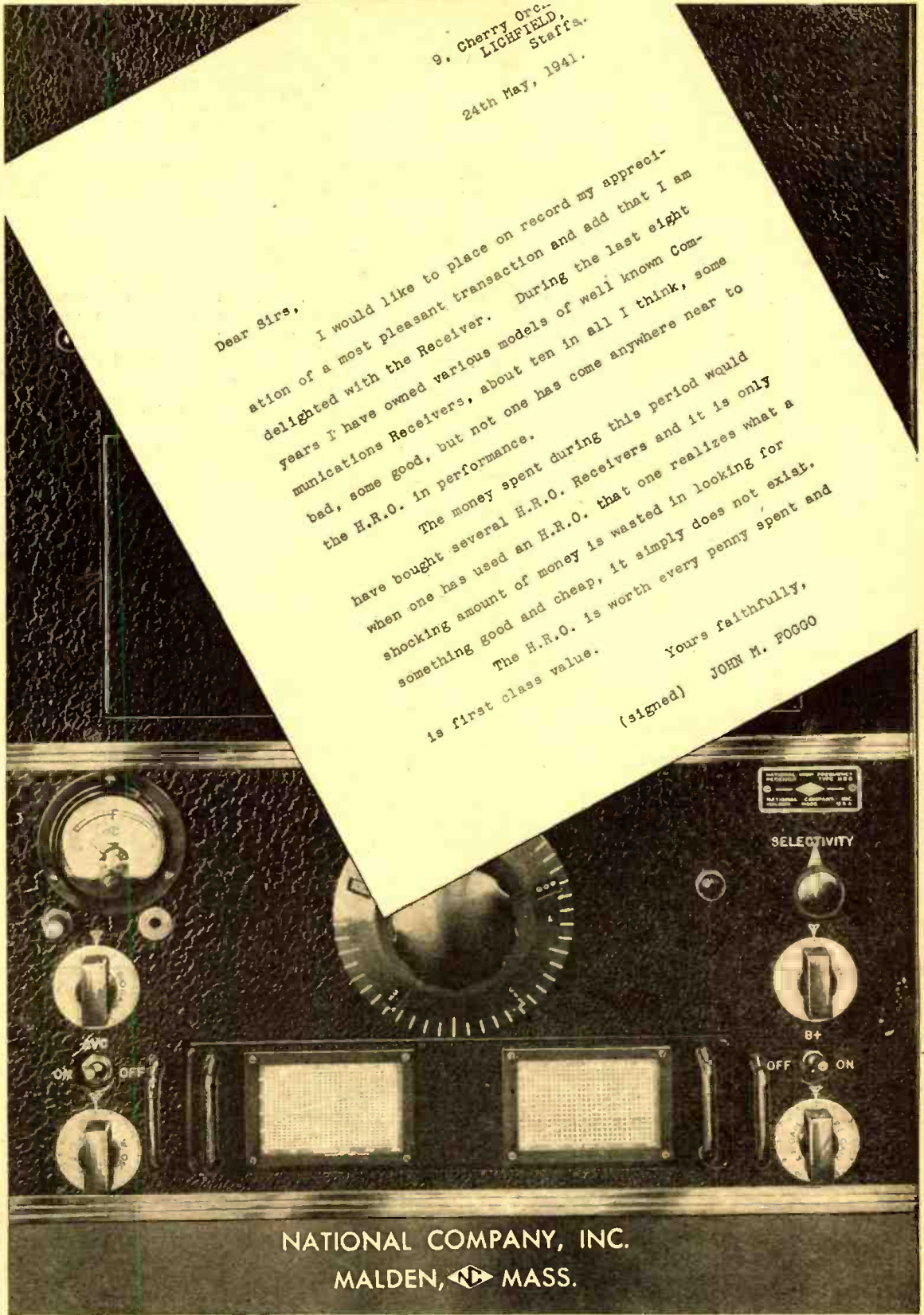

NATIONAL COMPANY, INC.
MALDEN, MASS.

larly avoided in high-frequency transmitters, since their inductive effect introduces a number of circuit disorders.

As in the case of the cathode bypass capacitor, the plate- or screen-circuit condenser must be capable of handling the current which will flow through it in its circuit position at the operating frequency. The current rating will vary with the frequency and capacitance, and the product of the reactance (at the operating frequency) and

the current must never exceed the working voltage of the condenser selected.

An added refinement to any transmitter is the employment of meter bypass condensers, such as C_8 , C_9 , C_{11} , and C_{12} . These serve to detour R.F. currents around the meters where they might cause severe damage or complete burnout of the delicate d'Arsonval movements. The same factors which govern the selection of the other condensers just described apply like-

Your Inquiries Invited!

YOU need assistance in getting the right short wave receiver for your use, and I can help you. I can make it to your advantage to buy from me. Here are five good reasons why it will pay you to write me before you buy.

1. YOU GET specialized personal attention of genuine value that you can't get from other jobbers.

2. YOU GET prompt shipment from the world's largest stock of all makes and models of amateur communications receivers.

3. YOU GET easy 6% terms which I finance myself so you have less cost—no red tape—quicker delivery. Write me for terms.

4. YOU GET best trade-in for your receiver. Describe it and I will tell you its trade-in value. Pay the balance on my 6% terms.

5. YOU GET ten-day free trial. You don't buy unless you are satisfied.

So write me and I will help you get the best communications receiver and will cooperate with you to see that you are 100% satisfied. Your inquiries invited.

Bob Henry
W9ARA

HENRY RADIO SHOP BUTLER MISSOURI

MODERN PARTS for MODERN CIRCUITS

THAT HAVE BEEN

*"Designed for
Application"*

CATALOG UPON REQUEST

JAMES MILLEN
150 EXCHANGE ST.



MFG. CO. INC.
MALDEN, MASS.

AMATEUR RADIO LICENSES

Study for your licenses the "rhythm" way, the A.R.I. way. Acquire code proficiency in from 3½ to 8 weeks. Theory taught in understandable, non technical language. Classroom courses in New York, home study courses for outside students. Write for list of calls of hundreds of licensed students now on the air.

AMERICAN RADIO INSTITUTE
1123 BROADWAY, NEW YORK, N. Y.

RADIO TECHNOLOGY



RCA Institutes offer an intensive course of high standard embracing all phases of Radio and Television. Practical training with modern equipment at New York and Chicago schools. Also specialized courses in Aviation Communications, Radio Servicing and Commercial Operating. For Free Catalog write Dept. RT-41.

RCA INSTITUTES, Inc.

A Radio Corporation of America Service
75 Varick St., New York, 1154 Merchandise Mart, Chicago

284

wise to meter bypass condensers.

In the elimination of A.C. line-hum components from the transmitted carrier wave, the electrical center of the tube filament circuit is grounded through an appropriate center-tapped resistor, such as shown with the 75T final amplifier tube in Figure 1. This method is quite effective. However, the resistor introduces a considerable amount of impedance to the flow of R.F. currents from the tube filament to ground; and to offset this undesirable effect, filament bypass condensers (C_{12} and C_{13}) are connected from each filament leg to ground to provide a low-impedance R.F. path. The capacitance of filament bypass condensers should never exceed .01 mfd. and their voltage rating may safely be approximately one-half of the D.C. plate voltage applied to the tube.

Coupling Condensers

Coupling condensers are used to transfer radio-frequency energy from one point to another, such as between the output circuit of one stage and the input circuit of another. The particular technique of energy transfer by condensers is termed *capacitive coupling* by transmitter engineers.

Figure 2 illustrates capacitive coupling as commonly employed between two R.F. stages in a transmitter. The coupling condenser, C , is connected directly between the plate of one tube, V_1 , and the grid of the succeeding tube, V_2 . A low-impedance path is thus provided for R.F. used to excite the grid of V_2 , while the latter is isolated from the V_1 plate voltage, E_1 .

In such an arrangement, the condenser actually conducts all of the R.F. current it is able to from the first stage to the second and must be rated to carry this current safely at the operating frequency. In addition, the condenser is subject to the D.C. plate voltage, E_1 , of the first tube, and the D.C. grid voltage, E_2 , of the second, which are effectively in series with each other. The D.C. operating voltage of the coupling condenser, then, must be better than the sum of these two voltages. For safe operation, the rating should be from 50% to 100% greater than the voltage sum.

The coupling condenser must have exceedingly high leakage resistance and introduce few losses, requirements that at once dictate the use of mica as a dielectric. It must be well protected from moisture, therefore well sealed in a low-loss insulating material.

The capacitance of the coupling condenser, which must be of such value as to provide low reactance at the operating frequency, will depend directly upon the latter. At the frequencies allocated for amateur, commercial, and experimental short-wave services this will generally be between .0001 and .002 mf. while in ultra-high-frequency applications the capacitance will more suitably be of the order of .00005 mf.

The coupling condenser provides a convenient and simple means of excitation control when this feature is desired, since varying its capacitance, and correspondingly its reactance, at a given operating frequency will cause corresponding variations in the R.F. driving voltage applied through it to the grid of a succeeding tube. In fact, the proper amount of "grid drive" for a given tube may be obtained easily through this expedient by raising or lowering the

coupling capacitance in appropriate steps.

Blocking Condensers

The blocking condenser, as the name implies, is used wherever it is desired to obstruct the flow of direct current through a circuit carrying R.F. or A.F. currents. C_6 and C_{10} in Figure 1 are examples of blocking condenser applications.

The plate circuit of the crystal oscillator tube, 6L6, is *parallel fed*; i.e., the D.C. plate potential is applied through a radio-frequency choke instead of through the plate tank. And in order to prevent a resultant short-circuit of the plate supply through the grounded tank circuit, the *blocking* condenser, C_6 , is interposed between the plate electrode and the tank. R.F. currents have no difficulty, however, in flowing from the plate to the tank circuit, or vice versa.

The grid circuit of the final amplifier is similarly parallel fed, and the blocking condenser, C_{10} , prevents a short circuit of the 75T grid bias voltage through the grounded grid tank circuit.

It is evident that the blocking condenser, in its function of separating A.C. and D.C. components, closely resembles the coupling condenser.

The factors influencing the values of capacitance, D.C. operating voltage rating, and permissible R.F. current for the blocking condenser are identical with those stated for the various types of bypass and coupling condensers and need no repetition.

Blocking condensers are becoming more widely known with the increasing popularity of parallel-fed transmitter circuits. The outstanding advantages of the parallel-fed over the series-fed circuit, responsible for its present adoption, are (1) the removal of dangerously high D.C. voltages from the tank tuning condenser, and (2) the permissible reduction in size and cost of the tuning condenser. To the blocking condenser may be accredited these important advantages.

Casing

Fixed condensers employed in transmitter R.F. stages should be of the hermetically-sealed type of construction, provided with short terminals, and physically as small as the required ratings will permit. In high-frequency applications, low-loss bakelite casing is recommended over all other types.

In order to prevent flashovers and to keep losses and stray capacitances at a minimum, metal casings should be avoided. Accommodations for mounting the high-voltage condensers firmly on the transmitter chassis are particularly desirable.

Special flat, bakelite-cased, meter bypass condensers are available with brackets for mounting directly to the screw terminals of the meter.—Courtesy *Engineering Department, Aerovox Corp.*

Electrical Articles Wanted!

● IF you enjoy the Electrical Department, page 306, send us a description of your favorite electrical stunt. We want articles on simple electric motors and methods of using them, electric meter test set-ups, high frequency furnaces, home-made battery chargers, home-made measuring instruments and bridges, etc. All articles accepted and published will be paid for at regular space rates. Be sure the photos are sharp and clear.—THE EDITORS

For the Ham

Two Little "Gem" Transmitters

J. A. Szabo, W9JOI

The One-Tube CW. A.C.-D.C.: This little rig has proven itself several times and in several different forms. While in radio school some copies of this were made and proved a cheap and efficient means of communication between "us guys."

The days of the California kw. are about over, since you can't work the foreigners anyway.

This is about the most compact, simplest, little stand-by or emergency rig you ever laid eyes on. Also the guy with the brand new precious little slip of white paper will scream for joy when he sees the parts list.

Construction: As far as construction goes, it would be left up to everyone to see how much space he can save by building one of these. The last model here was built up in a metal box 6 x 6 x 6 inches. There was quite a bit of space left over, after it was all put in the box.

Operation: Hook it to any good antenna and it will surprise you. Ours loaded up to about four watts. Condenser C2 is the only tricky adjustment. To start out with, it

should be set to maximum capacity since it controls the amount of voltage fed back to the Xtal. Not enough capacity here might crack a Xtal. Tune for maximum dip of the plate current and then adjust cond. C2 until the bulb in the Xtal circuit glows about half brilliancy. That's all there is to it.

3-Tube Phone A.C.-D.C.: Here is another one that is economical on the parts and is just the thing for chewing the rag on 160 Fone around town. This consists of a Pierce type oscillator, hooked up with a couple of those valuable 117L7's. The mike gets its excitation from the cathode bias resistance of the modulator. It is Heising modulated and if a decent quality choke is used as the common coupling impedance, it will have surprisingly good quality.

Please notice that in both rectifier plate circuits a 1/2 watt, 50 ohm resistor is used. Don't leave it out as the charging surge of the HI-Capacity input condenser is enough to send the peak plate current up far enough to ruin the rectifier sections.

Nuf sed, boys, let's see how you like working on "flea-power"!

The diagrams of the two small transmitters here shown will prove interesting to the Ham.

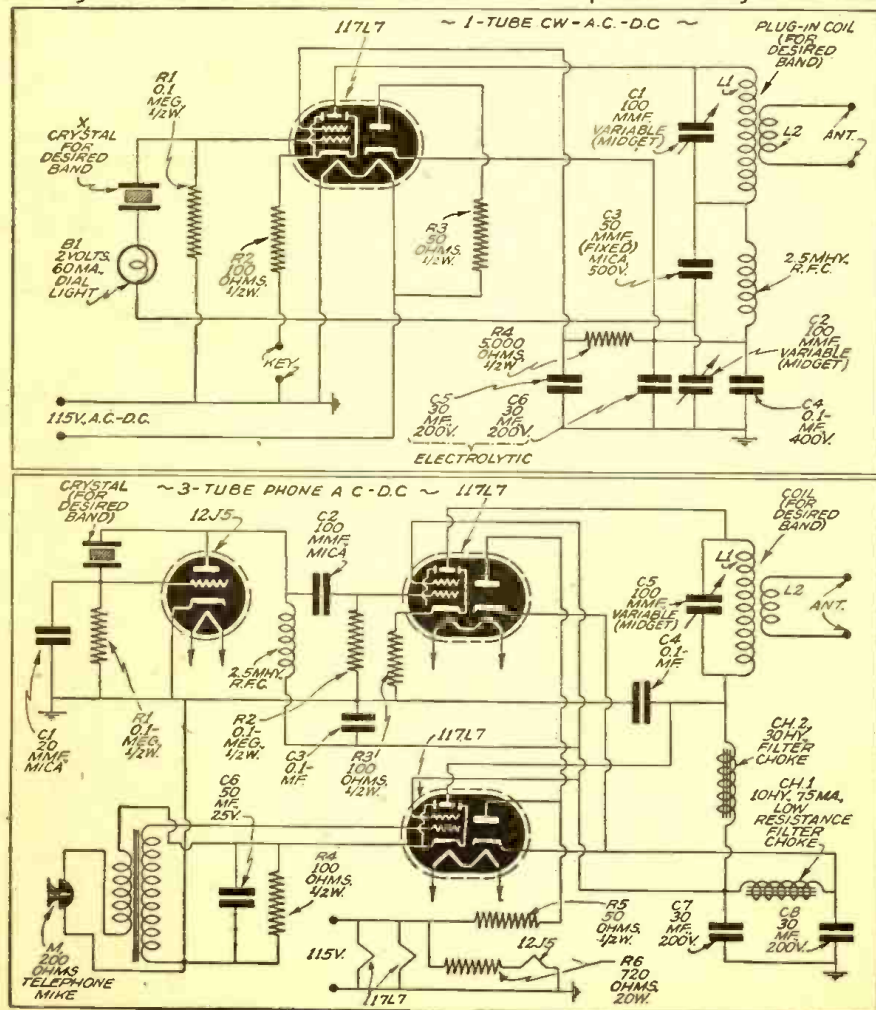

DEALERS
SERVICEMEN
AMATEURS
BUILDERS
P. A. MEN

NEW

FREE!
RADIO'S
GREATEST
CATALOG!



212 PAGES • BIGGEST YET!
SAVES YOU MONEY
ON EVERYTHING IN RADIO



50 NEW
KNIGHT
1942 RADIOS

See the new KNIGHTS for 1942—the greatest radio line in years! New "Personal" 3-way Portables; latest FM-AM models; Phonograph Recorders; World-wide Receivers; new Plastic sets; Farm Radios. There's a Radio for every requirement—and the prices are amazingly low! Get this 212-page 1942 Catalog!



SAVE ON
EVERYTHING IN RADIO
NEW SOUND SYSTEMS

PA at its finest—systems for every application—7 to 60 watts. Exclusive new features—easy Time Payment Plan—15 Day Trial Offer.

AMATEUR GEAR
All the new Communications sets—new x-mitters—new tubes and specialized Radio equipment.

15,000 RADIO ITEMS

Complete stocks of parts; tools; test equipment; books; tubes; etc. Over 15,000 radio items—all at lowest prices!



Builders' Kits

Builders need this 1942 book! New kits, diagrams, supplies—everything in radio for the builder. We'll supply parts lists for any circuit described in magazine radio construction articles.

Radio Builders' Handbook

Gives all the dope on building; easy to understand; illustrated. Only 10c

Radio Dictionary

Complete; defines commonly used radio terms. Only 10c

ALLIED RADIO

833 W. Jackson Blvd., Dept. 3-J-1
Chicago, Illinois

- Send your FREE 1942 Radio Catalog.
- Find 10c enclosed for "Builders' Handbook."
- Find 10c enclosed for "Radio Dictionary."

NAME
ADDRESS
CITY STATE



Top Right: Gerald Livingston, W2KGU (left); William Chrystal, W2DOS (right), 160 meter "Norfolk Amateurs" type phone transmitter, built and owned by Mid-Hudson Amateur Radio Club, Hallicrafters receiver owned by W2DOS. Top Left: Gordon R. Abell, Jr. (left) Robert Wingood, W2IYH (right), operating 3.5 mc. C.W. rig, working Albany and New York. Bottom Left: Two of first boats to reach the refueling point. M-8 was piloted by a Y.L. Lower Right: Cabin cruiser leaving Poughkeepsie Yacht Club with Daniel Lawrence, W2CGT and Edward Prichard and radio equipment aboard.

HAMS Report Motorboat Races

This is the interesting story of how "Hom" radio reported outboard motorboat races. The short-wave Amateur stations distinguished themselves in maintaining contact between the stations along the route of the races between Albany and New York.

● AMATEUR radio operators of Poughkeepsie, Albany, and New York City cooperated to provide short-wave radio communications to assist the participants in the annual Albany-to-New York Motorboat Races on Sunday, May 11th.

Portable amateur radio transmitters and receivers were set up at the Albany Yacht Club, starting point of the races; at the Poughkeepsie Yacht Club, mid-way refueling point for the racers; and at the finish line in New York City.

As each group of racers left the starting line, the Albany hams transmitted to Poughkeepsie and New York, via 3.5 mc. radio-telegraph, last-minute information as to changes in the entry lists, boats stranded and unable to start, and boats which actually were successful in getting away from the starting point. Boats of different sizes and varying motor powers, were handicapped various lengths of time in leaving the starting line, so as to give all partici-

pants an equal chance to win the 150-mile grind. The first group of boats left the Albany Yacht Club at 7:00 A.M., E.D.S.T., and the last group at about 9:00 A.M.

Then, as each boat reached the refueling point at the Poughkeepsie Yacht Club floats, the Poughkeepsie amateurs transmitted to Albany and New York the information as to which boat it was and the exact time it left Poughkeepsie for the second half of its journey to New York.

As the boats reached the finish line in New York, the sequences of the winners was flashed to the Poughkeepsie and Albany radio men, so this information could be given out to the friends of the race pilots, and other interested people, gathered at those places.

All of the aforementioned work was conducted on the 3.5 mc. C.W. band, with the exception of the fact that at both Albany and New York, in order to comply with the restrictions on portable operation

imposed by the Federal Communications Commission's Order No. 73, 2½- and 5-meter portable equipment was used at the riverfronts to flash the information to fixed 3.5 mc. C.W. stations located at the owners' homes, then being relayed out on 3.5 mc. at the latter locations. W2MIY was the call used for 3.5 mc. operation at Albany, with W2ITQ, W2LLK, W2LEI and other members of the Albany Radio Club participating in the operations also. At New York, W2MOZ was used on 3.5 mc. C.W., with W2LR, W2BGO, W2LBI, W2BUP, and others also assisting there. At Poughkeepsie, through the courtesy of a special order from the F.C.C. permitting the Poughkeepsie amateurs to operate portable on 28, 3.5, and 1.7 megacycles, W2IYH was set up as a portable 3.5 mc. station right at the Poughkeepsie Yacht Club, and most of the operating on this band was done by the holder of that call, Robert Wingood, assisted by Don Love, W2BJX.

MYSTERIOUS LODESTONE



We present our genuine DYNAMIC LODESTONE, the most remarkable natural live magnet known. Not man-made, but found in nature. Known as Magnetite. History abounds with legends about the mysterious power of Lodestone. Mohammed's coffin in the Great Mosque at Medina was supposed to have been suspended for centuries held in space only by powerful Lodestones.



Many regard Lodestone as being possessed with miraculous powers. It has been used for centuries as a charm and talisman. The ancients, from Phoenician to the Romans, believed that it had the power to attract love and keep it secure. The high castles in India thought that it created and preserved mainly vigor.

All our specimens are specially selected for high power.

50 Fascinating Experiments

can be performed with our DYNAMIC LODESTONE. We give full directions showing how these instructive and mysterious experiments can be performed even by a child. In addition to the Lodestone, we supply a genuine magnetic compass to show the power of Lodestone and a supply of iron filings to "bewhisker" the Lodestone. Entire outfit including Lodestone, compass, filings, directions, etc., only 50c. postpaid.

Order today! Send money-order, cash or new U.S. stamps.

NATIONAL PLANS INSTITUTE

246-T 5TH AVE. NEW YORK CITY



ELEMENTARY MATHEMATICS

EASY - SIMPLIFIED - PRACTICAL

HERE is a book for the business man, the technician and craftsman explaining and answering every operation and meaning with interesting illustrations and examples.

It is the key to a simple understanding of many perplexing problems in daily life. In clear, positive and definite language, the author popularizes and clarifies every subject and helps the reader to overcome any apparent difficulty in the study of mathematics.

A real home study-course in mathematics for the student or the man who wants to achieve proficiency or desires to brush-up on his knowledge.

Entire Chapter on Special Mathematics for the Radio Technician

CONTENTS OF BOOK

- CHAPTER I. Arithmetic—Addition—Subtraction—Multiplication—Division.
- CHAPTER II. Factoring and Cancellation—Fractions—Decimals—Percentage—Ratio—and Proportion.
- CHAPTER III. The Metric System.
- CHAPTER IV. How to Measure Surfaces and Capacity (Geometry).
- CHAPTER V. Powers and Involutions—Roots and Evolution.
- CHAPTER VI. Mathematics for the Manual and Technical Craftsman—Thermometer conversions—Graphs or Curve Plotting—Logarithms—Use of the Slide Rule.
- CHAPTER VII. Special Mathematics for the Radio Technician.
- CHAPTER VIII. Commercial Calculations—Interest—Discounts—Short Cut Arithmetic.
- CHAPTER IX. Weights and Measures—Useful Tables.

Send Stamps, Cash or Money Order.

"Elementary Mathematics" can be carried readily in your pocket

ONLY
50c
POSTPAID

TECHNIFAX

1917 S. State St. RT-941 Chicago, Ill.

"JIFFY"

Magazine Binder

Sturdily built and covered with black fabricoid. Has two stamped metal ends with 12 spring wire separators. Magazines can be inserted and removed in a jiffy. No fuss—no lost time—no labor.

- No. 1. 12 1/2" x 9 1/2". with 2-inch back for Radio-Craft, R.&T., Radio News, etc.— \$1.50
- No. 2. 10 1/2" x 7 1/2". with 3-inch back for QST, Radio, Popular Mechanics, etc. — \$1.25
- No. 3. 8 1/2" x 6 1/2". with 3-inch back for Reader's Digest, etc. — \$1.00

P.P. Prepaid in U.S. and Canada

GOLD SHIELD PRODUCTS

Dept. RT-941, 350 Greenwich Street, New York City

In addition to the 3.5 mc. communications net, the Poughkeepsie amateurs also conducted a special additional service to expedite the quick and efficient refueling of the boats as they arrived, as follows:

W2CGT, owned and operated by Daniel G. Lawrence, President of the Mid-Hudson Amateur Radio Club, was set up as a portable-mobile 28 mc. radiotelephone station on a cabin cruiser operating in the Hudson River in the vicinity of Crum Elbow, about four miles north of the Poughkeepsie Yacht Club. As each motorboat passed this observation point, the operators on the cruiser identified it by its number, and transmitted this number via 28 mc. radiotelephone to a relay station, W2AGZ, owned and operated by Paul Grant, and located for portable operation at the Hudson River State Hospital Yacht Club, on the east bank of the Hudson River about two miles from the point where the cruiser was operating; from thence it was transmitted via 1.7 mc. radiotelephone to the Poughkeepsie Yacht Club, and announced over a public address system to the crowd gathered there. This arrangement gave each refueling crew about 5 minutes' advance warning that their man was approaching, and enabled them to "gas up" his boat the minute it arrived, with none of the confusion and crowding around the float which characterized this work in prior years before the Mid-Hudson Amateur Radio Club members started to provide this service.

W2CGT was assisted on the cruiser by club member Edward Prichard, while W2AGZ was assisted by club member Fred Wohlfahrt. At the Poughkeepsie Yacht Club, the 1.7 mc. signals from W2AGZ were picked up by W2DOS, owned and operated by William Chrystal, and assisted by Gerald Livingston, W2KGU; James White, W2AXX. Other Mid-Hudson club members assisting in clerical work, etc., at the Poughkeepsie Yacht Club in connection with the radio operations, included Gurdon R. Abell, Jr., and Clinton Wallwork.

This was the fourth year that the Mid-Hudson amateurs had provided the short-distance "refueling" radio circuit for the motorboat racers, and the third year that the Albany and New York hams had also been in on the fun through the medium of the 3.5 mc. net.

The accompanying photographs show a few action shots of the operations at Poughkeepsie:

Photograph "A" shows Gerald Livingston, W2KGU (left) and William Chrystal, W2DOS, operating the 160-meter "Norfolk amateurs" type portable transmitter (built and owned by the Mid-Hudson Amateur Radio Club members).

Photograph "B" shows the cabin cruiser, with Daniel Lawrence, W2CGT; Edward Prichard, and other persons, and the necessary equipment, all aboard, leaving the Poughkeepsie Yacht Club dock.

Photograph "C" shows Gurdon R. Abell, Jr. (left), and Robert Wingood, W2IYH, in the 3.5 mc. corner, swapping messages with Albany and New York. The 3.5 mc. C.W. transmitter was built by W2CGT.

Photograph "D" shows two of the first motorboats to reach Poughkeepsie.

DON LOVE, W2BJX Secretary,
Mid-Hudson Amateur Radio Club

BUT WHAT OF Tomorrow?

"All-out" production to meet today's pyramiding orders does not mean that Triplett has lost sight of the broader requirements of tomorrow. Instead, research and engineering programs actually have been "stepped-up" to assure constant improvements in products and processes; in addition to needed developments in new fields.

Today's demands are important, but the needs of tomorrow cannot be slighted—and are anticipated in never flagging engineering and research developments. You have assurance that in the months and years to come, new Triplett products will serve in expanded fields, where they will merit values and savings for every dollar spent in their purchase.

THE TRIPLET ELECTRICAL
INSTRUMENT CO.
Bluffton, Ohio



LEARN CODE

the way you'll be using it
by SOUND



The best way to learn to read code is by listening to code. The best way to learn to send code is by hearing your own sending repeated back to you.

With the new All-Electric Master Teleplex Code Teaching Machine, you learn code the natural, easy, fascinating way. Only instrument ever produced which records your sending in visible dots and dashes—then SENDS BACK your own key work at any speed you desire. That's why practically every school teaching code uses TELEPLEX. We furnish complete course, lend you All-Electric Master Teleplex, give you personal instruction with a MONEY-BACK GUARANTEE—all at a surprisingly low cost per month. Write today for FREE catalog \$9. No obligation.

TELEPLEX CO., 107 HUDSON ST. JERSEY CITY, N. J.

BLILEY CRYSTALS

10-20-40-80-160 Meter Bands

Now \$3.35 up.

Bliley Electric Co., Erie, Pa.

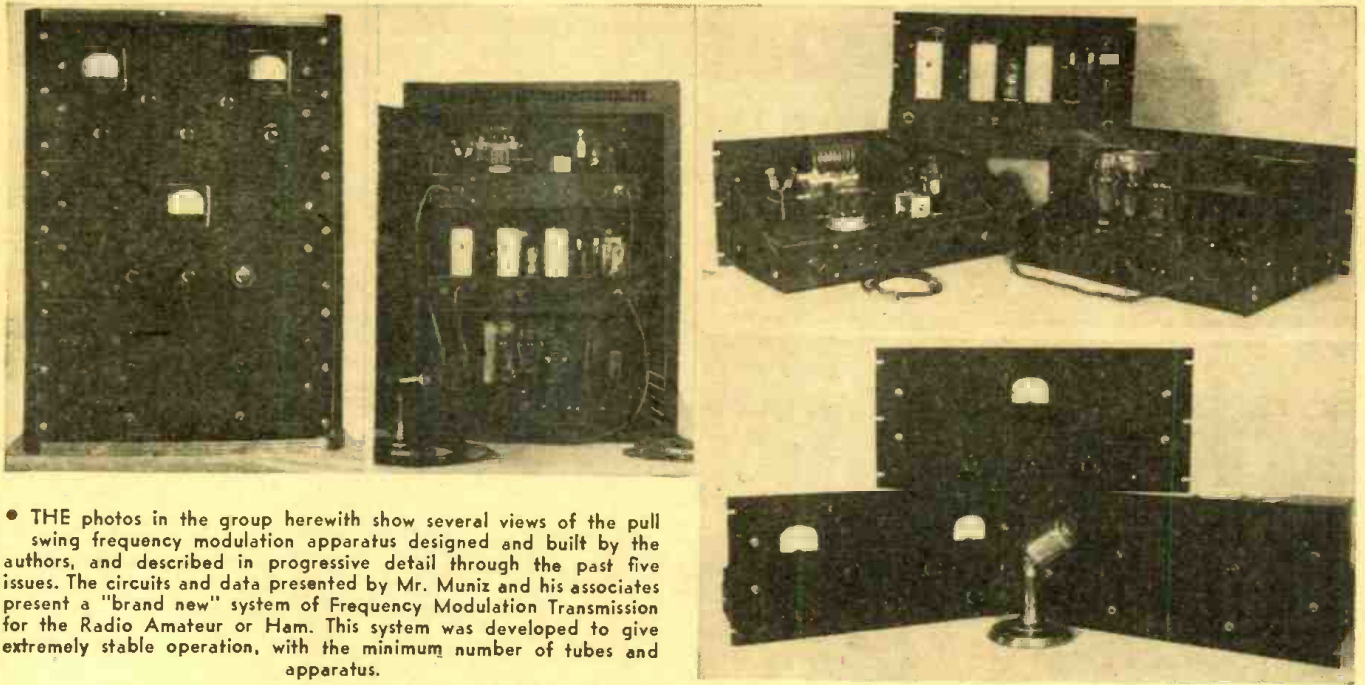

• THE photos in the group herewith show several views of the pull swing frequency modulation apparatus designed and built by the authors, and described in progressive detail through the past five issues. The circuits and data presented by Mr. Muniz and his associates present a "brand new" system of Frequency Modulation Transmission for the Radio Amateur or Ham. This system was developed to give extremely stable operation, with the minimum number of tubes and apparatus.

Pull Swing F-M System

No. 6 — Conclusion

Ricardo Muniz, E.E.*;

Donald Oestreicher**;

Warren Oestreicher***

Theory—The transmitter described makes use of a phenomenon known as "pulling"—a form of frequency control usually undesirable heretofore, because it is one cause of superheterodyne receiver instability. *Pulling* is the term applied to the effect on an oscillator of an injected voltage of different frequency from the natural resonant frequency of the tuned circuits of the oscillator. The frequency of the oscillations will be shifted toward the injected frequency an amount depending on the relative magnitudes of the two components, the amount of coupling between the injection circuit and the grid or control circuit, and the frequency difference.

Experiments were performed in order to determine whether this deviation could be made a linear function of the injected voltage, and it was found that this might be done over a large range of deviation without too critical a set-up. Since there is a secondary effect evidenced—that of heterodyne modulation of the carrier by the control components, it is necessary to include a *band-pass filter* in the output. This filter is also necessary to provide uniform response within the wide band required.

Following the actual modulator is a limiter, a heavily driven class "C" amplifier, which removes any amplitude variation which the master oscillator may develop. (This includes any power-supply ripple, although the ripple may show up as *frequency modulation*.)

In the preceding articles of this series the authors have described in detail all of the elements entering into the design and construction of our new system of frequency modulation. We now wish to present an integrated summary covering all the important features of the system.

Description of units—The most important unit is of course the *modulator rack*, for this is a complete low-power transmitter in itself. On a 3" x 7" x 17" chassis is the audio amplifier, the frequency modulator and the limiter, with the filament transformer for these stages. There are actually seven different radio frequencies present on the chassis at one time, plus the high-gain audio system. Since this condition requires careful shielding, commercial practice was followed by mounting all tuned circuits in *shield cans*. Contrary to expectations this offered no complications whatever.

The audio line-up is: 6SJ7 voltage amplifier, 6C5 driver and 6L6G output tube. This line-up provides sufficient gain to work from an American DT-500 dynamic microphone, with more than enough output. The 6L6G works into a modulation transformer and amplitude modulates the two control oscillators.

Modulator—The modulation takes place in three oscillators—two designated "con-

trol" and the other the "master."

The control oscillators are modulated in amplitude, 180° out of phase with each other. They are conventional "tri-tet" crystal oscillators with output frequencies of 14.79 and 14.83 mc. The master oscillator is an electron-coupled circuit. The output tanks of the control oscillator are tuned to the mid-band frequency (14.81 mc.) and then are *over-coupled* until the band-pass circuit they form embraces the entire spectrum from 14.79 to 14.83 mc. The center band response is brought up by the grid tank of the master oscillator, which is tuned to 14.81 mc. and coupled to the midpoint of the output coupling of the control tanks. The usable bandwidth over which the master oscillator grid circuit may be pulled is plus and minus 10 kc. (corresponding to an output bandwidth of 80 kc.; about one-half commercial practice) with a maximum audio frequency of 9000 cycles. This leaves a guard band of 1 kc. on either side between the F. M. and A. M. sidebands. The elimination of the A. M. sidebands of the control oscillators is enhanced by the band-pass circuit which forms the output and input circuits of the master oscillator and limiter respectively.

Details—The power is supplied to this chassis, as for the others through Amphenol six-wire cables and connectors; thus, there are no exposed terminals. The microphone jack and coaxial line output jack are also by Amphenol. The meter (0-100 ma.) is switched into the various circuits. The oscillator ranges are shunted for 0-10 ma. range, to provide more sensitive indica-

*Radio Instructor, Brooklyn Tech. H. S. Eng. WYNE
 **Student, Electrical Eng., Brooklyn Polytech. W2LOE
 ***Student, Electrical Eng., Cooper Union, Night.

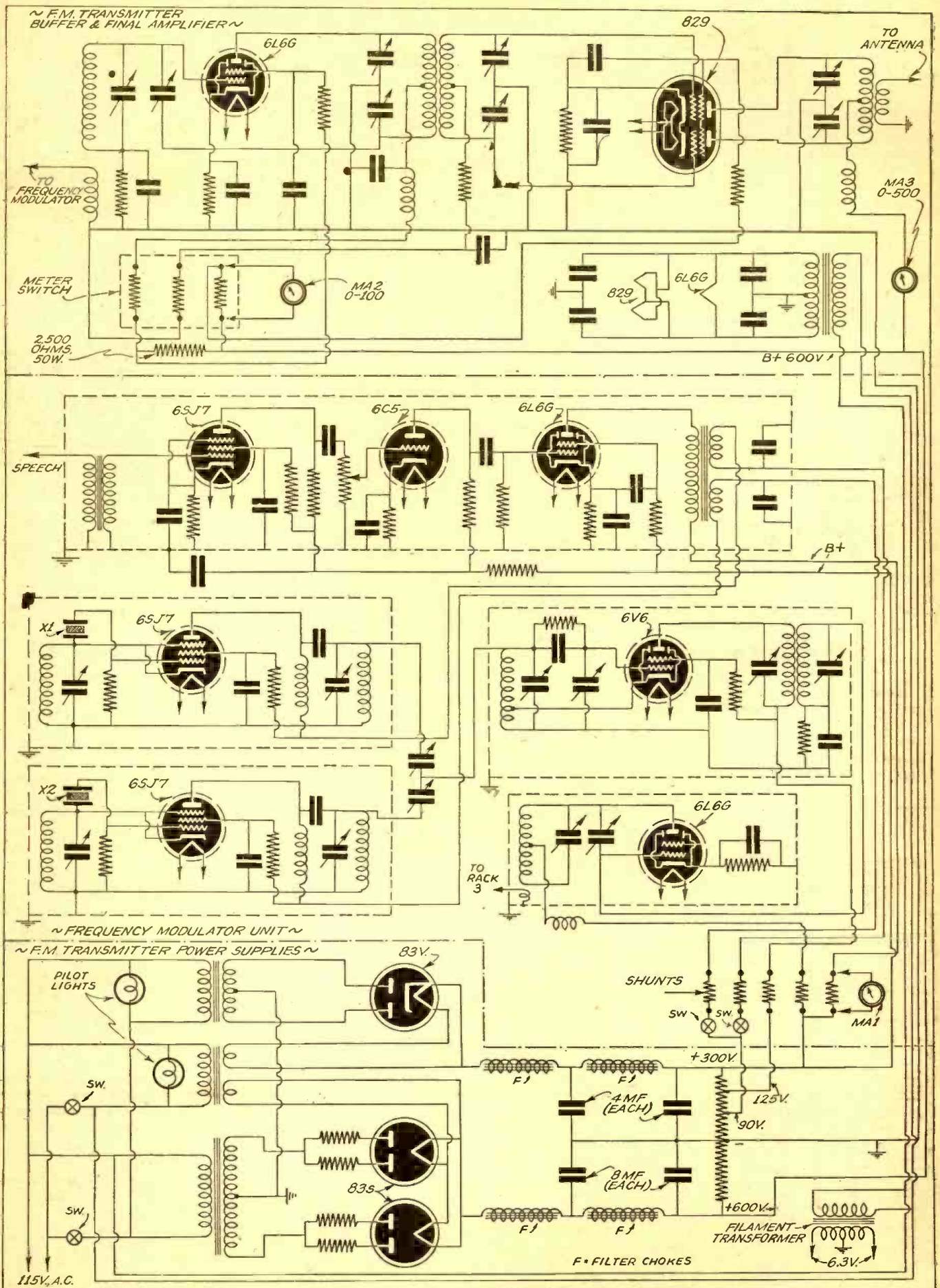

The diagrams above show some of the novel features of the Pull-Swing Frequency Modulation system developed by Mr. Muniz and his associates. Improved quality, with a strong radiated signal—characterized by great stability, are features of this new "FM" system for "Ham" transmitters.

★ ★ ★ ★ ★

UNCLE SAM NEEDS YOU! LEARN CODE NOW

FUTURE DRAFTEES ATTENTION! A rapid rise in rank along with a corresponding increase in pay is guaranteed you *when* you can qualify as a trained code operator in Uncle Sam's Communications Division.

BE ON YOUR TOES—get ahead of the other fellow—start learning code now by the easy, practical **CANDLER** way right in your own home!

DON'T DELAY—
CLIP AND MAIL THIS COUPON NOW!
**CANDLER SYSTEM COMPANY, DEPT. S-9
DENVER, COLORADO**

I am interested in preparing myself for the Army, Navy, or Commercial Communications field. Please rush me my **FREE** copy of the 52-page **BOOK OF FACTS**.

NAME

ST. & NO.

CITY STATE

★ ★ ★ ★ ★

PERSONAL SERVICE

By *Bill Harrison*

RECEIVERS AMATEUR EQUIPMENT

Fastest service—lowest prices—most liberal trade-in allowances—easiest time payment terms—in the country!

It will pay you to write to me about any Radio Apparatus you need. I guarantee you complete satisfaction and my personal attention.

73,
Bill Harrison, W2AVA
*Send stamp for my latest list of
NEW AND RECONDITIONED RECEIVERS

HARRISON RADIO CO.

12 WEST BROADWAY - NEW YORK CITY

EASY TO LEARN CODE

It is easy to learn or increase speed with an Instructograph Code Teacher. Affords the quickest and most practical method yet developed. Available tapes from beginner's alphabet to typical messages on all subjects. Speed range 5 to 40 WPM. Always ready—no QRM.

MACHINES FOR RENT OR SALE

The Instructograph Code Teacher literally takes the place of an operator-instructor and enables anyone to learn and master code without further assistance. Thousands have used and endorse the Instructograph System. Write today for full particulars and convenient payment and rental plans.



INSTRUCTOGRAPH COMPANY
Dept. RT, 4701 Sheridan Rd., Chicago, Ill.
Representatives for Canada
Radio College of Canada, 54 Bloor St. West, Toronto.

COMMERCIAL RADIO INSTITUTE

A radio training center for over twenty years. Well equipped. Excellent faculty. Practical resident courses in Radio Telegraphy, Broadcast, Servicing, Industrial, Television, Aeronautical, Drafting, Mathematics and Studio Technique. Placement Bureau. Fall term October 6. Catalog upon request.
Dept. E, 38 West Biddle St., Baltimore, Md.

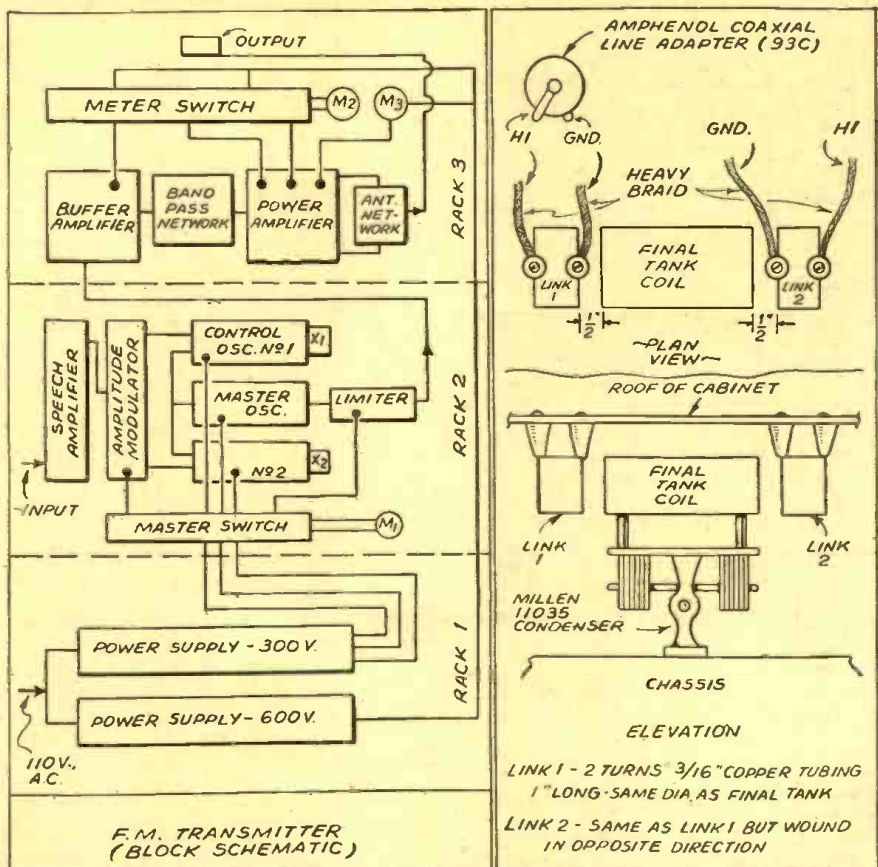

Illustration above shows block diagram of F-M Transmitter and details of link-coil arrangement.

tion. The meter should normally be left in one of the control oscillators to indicate possible over-modulation. (This will cause a downward deflection of the meter.) Three controls are brought to the front panel—the audio gain control, the oscillator bandspread condenser and the meter switch. All other adjustments are permanent and are made from the back.

Amplifier—The buffer and final amplifier are on the top rack. The constructional details are similar to the modulator rack in that all power is entered through an enclosed plug, the input from the modulator is through an Amphenol coaxial line and fixtures, and the meters are switched into the various circuits with a Mallory "Ham-switch." There is a difference, however, in that all controls except neutralization and coupling are brought to the front panel. This was thought to be advisable since the transmitter may readily be converted to the A. M. system, either by replacing the modulation rack with an audio system capable of delivering 30 or 40 watts for plate modulation, or by utilizing the F. M. audio system and, through a suitable switch and matching transformer, converting it for *cathode modulation*. Since the 829 requires less than a half-watt driving power, the 6L6 buffer may be readily converted to a crystal oscillator and with a 20 meter crystal, enough 5-meter harmonic should be present to provide adequate "drive." The rack may be driven from a homemade or commercial exciter in which case the accessibility of all controls will be a definite advantage.

The grid and plate circuits of the 829 are on opposite sides of the chassis and

therefore little trouble may be expected with oscillation in this stage.

The antenna coupling device is conventional except in one respect. It is coupled to the "hot" ends of the tank. It consists of two 2-turn links, one side of each of which is grounded. The grounded side is the one near the plate ends of the coil. Since the photographs do not show this system, a diagram has been included. The links are fastened to the top of the cabinet, on ceramic standoff insulators, in such a position that they will have the proper relationship to the coil when the final amplifier shelf is mounted. The links are connected to the Amphenol polystyrene adapter for 1/4" coaxial transmission line (also by Amphenol) with 1/2" copper shielding braid. The ground ends of the links should be connected to the ring of the adapter with braid. It is well to ground the chassis at this point, since this will prevent burns from local circulating R. F. currents or shock from accidental breakdown of the insulation. A conventional doublet aerial will be satisfactory for all use at the bandwidth indicated in the articles (i.e., 80 kc. for 9,000 cycle maximum audio frequency, 112 kc. for 15,000 cycle maximum audio frequency).

Power Supplies—The power supplies are conventional in every respect except that they are perhaps, more conservative than the usual amateur affair. This rack uses highest quality parts all with an appreciable *factor-of-safety* since we felt in heavy current applications, such as this, a great deal of damage to equipment and to the operator might result from breakdown of faulty or inferior components. No fila-

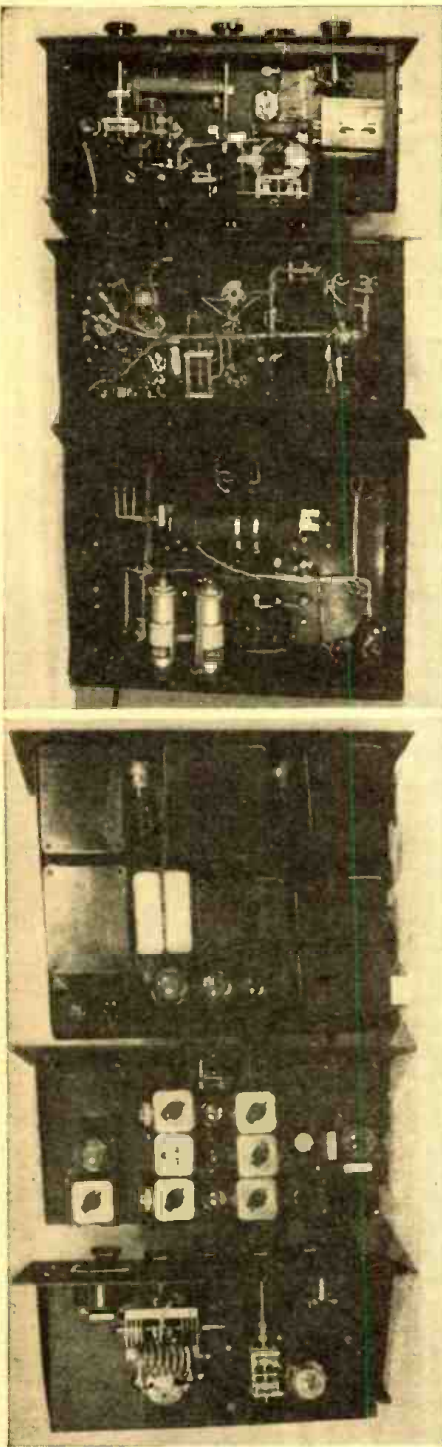

The two photos above show top and bottom views of the three main units of the "pull swing" F-M Transmitting System.

ment supplies are incorporated on this chassis. Instead, 110 V. A. C. leads are run through the cable to each chassis and the filament transformer is mounted near its associated circuit.

We may seem to be over-emphasizing but we cannot recommend too strongly the cable-and-plug method of distributing power at less than 600 volts. It is absolutely safe! For voltages over 600 an Amphenol coaxial adapter and a length of heavy single conductor, rubber covered wire affords excellent protection. If the wire is shielded no harm to the operator can result from an insulation breakdown.

The most critical parts of the power chassis are the 83 type rectifiers. Inferior tubes have a tendency to flash over at the stem. It is worth while to spend a few cents more and buy better tubes! We used 1 inch "bull's-eye" pilot lamps, not only for appearance but because with them there is little chance of leaving the power on accidentally!

Operation—The first step in "tuning up" is to align the modulator chassis. With a 7406 kc. crystal, tune first one control oscillator, then the other. The coupling condenser should be set at minimum. With one control oscillator operating on 7406 kc. tune the master oscillator grid, either for zero beat on a receiver or for maximum reaction on the control oscillator plate current. Now tune the succeeding stages in the conventional way. When this is done, plug in 7416 and 7396 kc. crystals, retune the control oscillator cathode circuits and, with a steady audio note of about 1000 cycles into the microphone jack, increase the coupling of the control oscillators until no distortion is heard in the receiver. When this is done, insert the chassis in the cabinet and connect it to the final amplifier, tuning up this unit in the conventional manner. Now the transmitter is all ready for the air. Connect the microphone to its cable, set the gain control to the point where over-modulation does not occur and lean back for a static free, untroubled "rag-chew."

- Remember, with this system you cannot:
- 1—Splash over (cause interference in other bands).
 - 2—Drift out of the band.
 - 3—Drift out of the selected F. M. channel.

And—if you build your rig to these specifications you can, as we did, give the unit a series of 24 hour breakdown tests at 10% increased line voltage, without an undue temperature rise or the breakdown of a single part!

A CALL TO ARMY MEN!

The Editors would like to hear from radio men in the service as to what kind of articles they would like to see in **RADIO & TELEVISION**.

Do you want more articles on "how and why"—including the mathematics, of frequency modulation?

Or do you want more *Elementary Electricity* articles with electrical hints, circuits and constructional data?

Or do you want more articles on *Antennas, Ultra Short Waves*, etc.?

Let's hear from you and we will endeavor to publish what you most need. A post-card will do. Write to the Editor, **RADIO & TELEVISION**, 20 Vesey St., New York City.



RADIO made EASY

LEARN AT HOME - IN SPARE TIME!

36 VOLUMES in 1 Big Book!

1. Broadcasting System
2. S. v. a. n. d. S. p. e. e. c. h. Music.
3. E. l. e. c. t. r. o. n. Theory: Electric Current.
4. E. l. e. c. Units: Ohm's Law.
5. Electric Circuits: Batteries.
6. Magnetism.
7. Electromagnetism.
8. Electromagnetic Induction.
9. Inductance.
10. Capacitance: Condensers.
11. A. C. Circuits.
12. Filters.
13. Measuring Instruments.
14. Radio Waves.
15. Broadcasting.
16. Receiving.
17. Vacuum Tube Principles.
18. V. T. Characteristics.
19. Vacuum Tube Construction.
20. V. T. Detector and Amplifier Action.
21. Radio Frequency Amplification.
22. "Superhets."
23. R. F. Amplifiers: Tuning Coils.
24. Audio Amplifiers.
25. Loudspeakers.
26. Battery Receivers.
27. Power-Supply Units.
28. Electric Receivers.
29. Auto and Aircraft Radio.
30. Phono Pick-ups: Public Address.
31. Short-Waves.
32. Photoelectric Cells: Cathode-Ray.
34. Television.
35. Antennas and Grounds.
35. Testing: Servicing.
36. Sound Pictures.

Ghirardi's COMPLETE Course will train you QUICKLY

Here's your BIG CHANCE to get a thorough training in basic **RADIO FUNDAMENTALS**—quickly, easily. There are BIG OPPORTUNITIES and lots more jobs for men with radio training—in radio factories, in radio service shops—and in all branches of the Army and Navy.

RADIO, SOUND, TELEVISION — MADE EASY AS A. B. C.

Ghirardi's famous **RADIO PHYSICS COURSE** is the cheapest, quickest radio training you can get. The whole science of Radio, Sound, & Television in a form completely intelligible even to beginners without any previous radio experience. Clear explanations and 856 self-testing Review Questions make it as easy to understand as a primer. Thousands of successful radio men got their start with this book, and it's used by more radio schools and students than any other radio text in the world! Get this whole 972-page course today for only \$4—and get started on your own radio career!

Use it 5 Days — OUR RISK!

Your money back if not fully satisfied. Don't delay—get started now—mail this coupon at once!

372 Pages
508 Illus.
\$4
Only 4

CLIP OUT — AND MAIL!

Radio & Tech. Publ. Co., Dept. R&T-91, 45 Astor Pl., N. Y.

Enclose \$4.00 (foreign) for my copy of "RADIO PHYSICS COURSE" with your 5-day Money-Back Guarantee.

Name

Address

City, State

Send me free literature.

C O D E

YOU CAN LEARN IT QUICKLY AND EASILY

Our way is fun while learning



Why not learn to be an operator quickly and easily with the

Ayers Automatic Code Machine all electric, 50,000 words practice tapes available, low monthly rental.

TAPES FOR MAC AUTOS. RECORDING SLIPS AND RECORDING INKS

Write

AYERS AUTOMATIC CODE MACHINES

711 Boylston St., Boston, Mass.

Headset Headquarters

CANNON-BALL



Phones have kept in the lead for over twenty years through real performance. Write for Folder T-27 illustrating complete line of rugged, unusually sensitive, dependable Cannon-Ball Headsets.

Scientifically Built Heavy bar magnets greatly increase their efficiency.

C. F. CANNON COMPANY
SPRINGWATER, N. Y.

at these frequencies) to ground. The induced secondary circuits will act only on coil S2, since S1 has too few turns at these frequencies, and coil S3 is by-passed at these frequencies by C2.

With the receiver tuned to broadcast frequencies, antenna C plus E also pick-up the tuned signal. This signal current flows through P2 with no effect, because of P2's low inductance to these long waves, but now flow through P3 and to Ground. The induced secondary currents at these frequencies flow through S1 and S2 without effect, because their inductance is too low, but flow effectively through S3 and into the transmission line into the radio.

The antenna is protected against lightning when windings 2 and 3 are in use. To protect the antenna against lightning charges on ultra-high frequencies, the resistor R is used to leak off the charges.

Figure 2 shows the Model 200 mounted on a three-sectioned galvanized mast. The dotted lines indicate that the elements are adjustable.

When one considers the care exercised in the selection of a good speaker, linear amplifiers and high-fidelity tuners, it becomes apparent that the antenna also must be mighty good, if maximum results are to be obtained.

The Electronic Testing Laboratory has been organized to build and test popular circuits and electronic devices intended for publication. (This is an independent laboratory and has no connection with this magazine.)

While tests will be of semi-laboratory procedures, the accuracy will be beyond that required for the practical constructor.

The constructor and user of radio devices are assured that Electronic Testing Laboratory will use every precaution in its recommendations.

Suggestions for articles from readers of RADIO & TELEVISION will be considered.

G.E. SHORT WAVES IN SIX LANGUAGES

"*News of the Week in Industry*," a business news broadcast emphasizing the National Defense program is being carried in six languages to Latin-America, Europe and Asia. It is going out over three G.E. short-wave stations, WGEO and WGEA, Schenectady, N. Y., and KGEI, San Francisco, Calif., and is designed to provide an up-to-the minute and authoritative report on the National Defense program. Based on material obtained through the facilities of "Business Week," the program has been heard weekly over a selected list of NBC blue network stations for some months.

The short-wave broadcasts already definitely scheduled are as follows. The hours given are on Eastern Standard Time, are: English, over WGEO, directed to Latin-America, Thursdays, 10:30 p.m.; English, over WGEA, to Europe, Fridays, 2:30 p.m.; Spanish, over WGEO, to Latin-America, Fridays, 9:05 p.m.; Portuguese, over WGEA, to Brazil, Fridays, 5:30 p.m.; French, over WGEO, to Europe, Fridays, 3:30 p.m.; Dutch, over WGEO, to Europe, Fridays, 2:45 p.m. Hours will be announced later for the Spanish, Dutch and Chinese versions—the first beamed on Latin-America, the last two on Asia—to be carried by KGEI.

for September, 1941

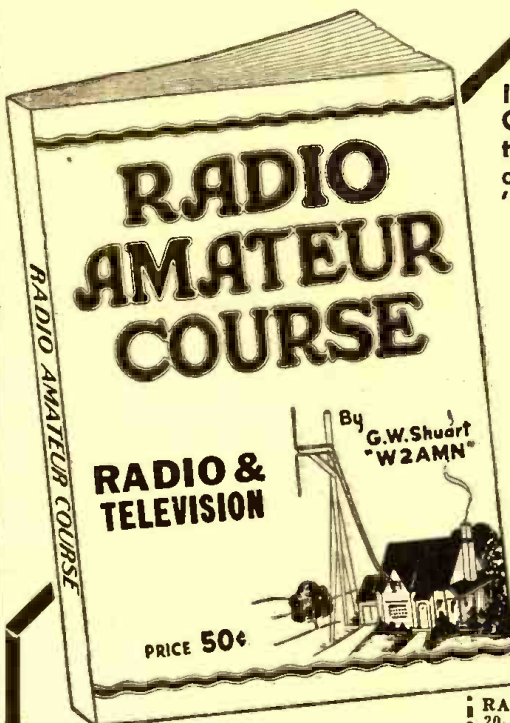

148 PAGES
6¼ x 9½ INCHES
OVER 150 RADIO DIAGRAMS
AND TECHNICAL PHOTOGRAPHS

RADIO AND TELEVISION
20 Vesey Street New York, N. Y.

Your Money Back—

If the RADIO AMATEUR COURSE does not represent the greatest book value ever offered to the radio "fans" for **50c**

To convince you that there isn't a better book buy today, the publishers of the RADIO AMATEUR COURSE make the sensational offer of a money-back guarantee on such a low-priced book. Stop in at any of the many dealers handling this book and examine it. See for yourself if the RADIO AMATEUR COURSE isn't just the book you've always wanted.

Printed on the finest coated paper—well illustrated attractive 4-color cover—complete with radio information you must have. It contains a step-by-step program for obtaining a short-wave radio education.

Written by George W. Shuart, W2AMN, foremost short-wave authority

RADIO AND TELEVISION
20 Vesey Street, New York, N. Y.

Gentlemen: I enclose herewith my remittance of Fifty Cents (50c) for which please send me POST-PAID, my copy of the RADIO AMATEUR COURSE. (Remit by check or money order; register letter if you send cash or unused U. S. Postage stamps.)

Name
Address
City State R&T-9-41

Write With This Time-Tested Pen Read This Proof Of Its Durability and Quality

Laughlin Mfg. Co.,
Detroit, Mich.
Gentlemen:

Enclosed find money order for \$1.50 for one of your ink pencils.

It may interest you to know that over 25 years ago I bought one of your pens after reading your ad in Our Sunday Visitor.

I used it for 15 years and then gave it to my brother, who lost it. The pen wrote splendidly up to the time it was lost.

Yours truly,

(signed) B. F. Conroy.

No. Easton, Mass.,
April 29, 1941.

An actual letter received from a satisfied customer of years ago who buys again.

**YOUR CHOICE
\$1.00 P'PAID**

Try either or both items for ten days at our risk. If not entirely satisfactory and as represented return it and we will refund purchase price.

Choose either the fountain pen or the ink writing pencil, and you will have a fine quality, durable, guaranteed, writing instrument!

The safety self-filling fountain pen is fitted with a 14 kt. solid gold iridium tipped pen. The safety self-filling ink writing pencil has a 14 kt. point also. Both are fully guaranteed 14 kt. solid gold, and for workmanship and satisfactory service.



ILLUSTRATIONS
2-3 ACTUAL SIZE

DE LUXE GIFT OF BOTH IN BOX FOR \$2.00

Splendid for School—for Boys in Training Camps—for Christmas Here's writing satisfaction! Both items in satin lined gift box—\$2.00 postpaid. Excellent for school—for boys in training (clips meet military regulations)—for birthday and Christmas gifts. Order today.

Laughlin Mfg. Co. 963 Majestic Bldg., Detroit, Mich.

LAUGHLIN MFG. CO. 963 Majestic Bldg., Detroit, Mich.

Please send the following for which payment of \$..... is enclosed:

- _____ Safety Self-Filling Fountain Pen \$1.00 postpaid.
- _____ Safety Self-Filling Ink Writing Pencil \$1.00 postpaid.
- _____ De Luxe Sets of Fountain Pen and Ink Writing Pencil \$2.00 postpaid.

Name
Address
City State

Please Mention This Magazine When Writing Advertisers

Frequency Modulation Receivers

F. L. Sprayberry*—Part I

• A frequency modulated wave may be said to be an ultra-high frequency from 42 mc. on up to 200 mc. At present regular assignments are from 42 to 50 megacycles (mc.). In this band, which is 8 mc. wide, if we place the maximum frequency deviation for each F.M. station at 200 kc.—that is, 100 kc. each side of the carrier—we will have channel space for $8/2 = 40$ stations in one locality (converting 200 kc. to .2 mc.). This provides a 200 kc. separation between carriers, which in the present state of F.M. development, is entirely adequate for the purpose.

The frequency modulated wave requires channel space for its "side frequencies" in

Radio students, we are sure, will welcome this new series on Frequency Modulation prepared by the well-known expert, F. L. Sprayberry, President of the Sprayberry Academy of Radio. As Frequency Modulation stations are growing in number daily, it behooves every radio student to familiarize himself with this newest branch of radio.

that the design is such that the frequency deviation is controlled solely by the modulating amplitude, and the maximum amplitude and frequency deviation may be fixed as well as their ratio.

Choice of Receiving Circuit

While the superheterodyne circuit is advantageous and highly desirable for broadcast reception in the regular broadcast band, it is essential in the F.M. and other ultra-high frequency bands for any service but telegraph. There is no practical substitute for this receiving circuit in this class of work. The main reasons why a superheterodyne is essential are (1) the gain per stage can be greatly increased by using a lower frequency than the carrier and (2) the selectivity per stage is much greater and is under better control. All of the other advantages of the superheterodyne also serve to make F.M. reception practical.

Receiving Antenna

As for all types of communication at ultra-high frequencies, the doublet or dipole antenna is universally used in F.M. The terms doublet and dipole are simply two different names for the same thing—that is, a half-wave Hertzian type antenna with center feed or lead-in. For transmitters, the wire or wires or conductors connecting the antenna to the transmitter are called "feeders," while the counterpart in a receiving installation is called a lead-in.

If the transmitting dipole elements are mounted vertically, the transmissions are said to be vertically polarized. In this event, best reception is obtained with a vertical receiving antenna which receives vertically polarized waves best. Likewise, a horizontal antenna producing horizontally polarized waves is best received by a horizontal antenna. The horizontal antenna, however, is slightly directional, having the greatest radiation from either side and the least from either end. The difference in signal strength, however, is not significant. Nevertheless, the vertical antenna is entirely non-directional and has this advantage over the horizontal type.

Polarization means "a state of having direction," and in the case of a magnetic wave, it is the direction in which maximum potential differences or voltage poles will be produced in the intercepting conductor. The magnetic lines of force radiating from any vertical antenna are, of course, horizontal and circular. Such waves will induce maximum voltage in a vertical conductor and are hence referred to as vertically polarized in their ability to induce energy in a conductor or simply vertically polarized.

Because of curvature of the wave itself or, as we often say, "curvature of the wave front," and also because of certain influences in the transmission path tending to

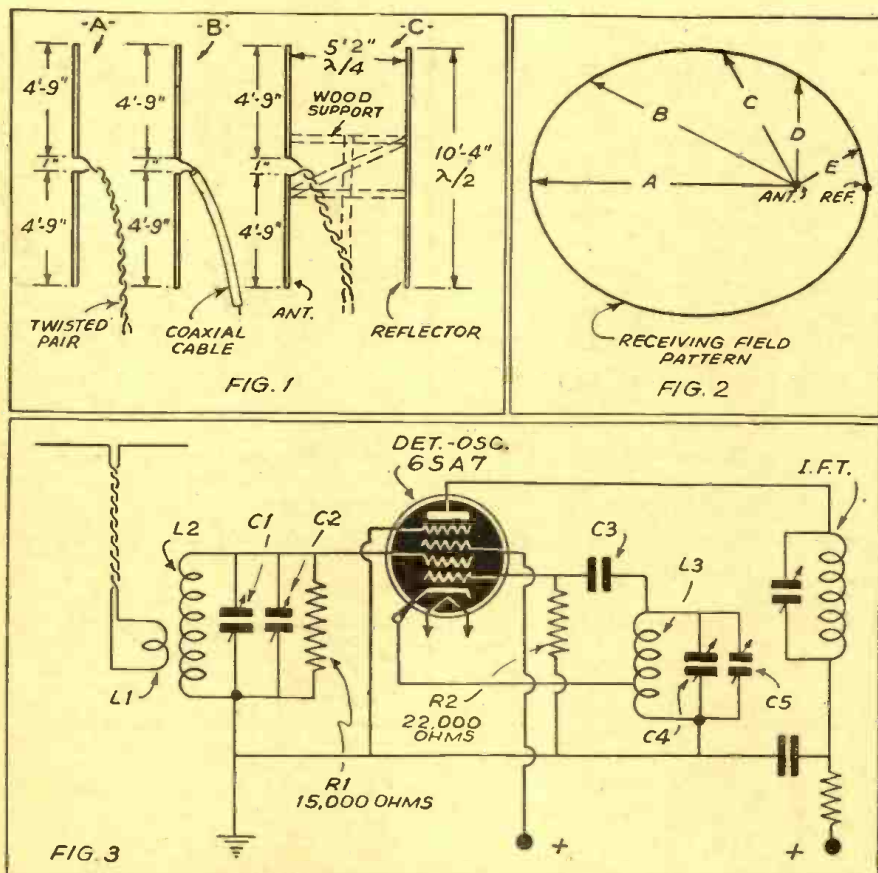

Fig. 1 shows relation of doublet antenna and reflector. Fig. 2, typical receiving field pattern for dipole. Fig. 3 shows typical detector-oscillator input circuit for an F.M. receiver.

the same sense that an amplitude modulated wave requires channel space for its sidebands. The side frequencies for F.M., however, are somewhat greater numerically than the actual modulation frequencies. For example, if we amplitude modulate any carrier with say 10,000 cycles, the side bands will not extend more than 10,000 cycles either side of the carrier, while the same modulation frequency with an F.M. set-up may produce a shift in frequency of

100 kc. each side of the carrier as we have seen.

Even at that, we have disregarded the F.M. "side-bands" which are more numerous than for A.M. In fact, as we have seen in the F.M. transmitter study, the greater the frequency deviation as compared to the modulation frequency, the greater will be the fidelity possibilities. We must not assume from this that the modulation frequency in any sense is allowed to control the frequency deviation, for we have seen

*President, Sprayberry Academy of Radio.

change the polarization from the vertical, some energy may be picked up by a dipole antenna in any position. The same cannot be said of a loop antenna because of its own characteristic field pattern.

From the above, we can assume that if the transmitter whose signal we desire to receive uses a vertical dipole, we should use a vertical dipole also for reception. On the other hand, if the transmitter uses a horizontal antenna, it would be best to use a horizontal antenna for the receiver. With either type at the transmitter or receiver, reception will, of course, be possible but not maximum under ordinary conditions.

Next, considering the length of the dipole units of the antenna, we may recall that this depends on the frequency of operation. Desiring the antenna to be capable of tuning over the entire F.M. band, we must choose a mid-frequency and design the antenna for this. For the most part, all of the F.M. transmissions of interest in regular broadcasting are confined in the band 43 to 50 mc. If we design the antenna for a mid-frequency of $46\frac{1}{2}$ mc., we can make it suitable for the entire band 43-50 mc. without much loss, due to frequency difference. This requires an antenna of moderately low "Q" or one that is not critically resonant to any one frequency. Such an antenna requires conductors of large diameter.

Within certain limits the larger the diameter, the lower the "Q" of the antenna. Experience and measurements have shown that a conductor diameter of $\frac{3}{8}$ " is sufficient for this purpose and superior to the usual wire for the purpose. Such a conductor is, of course, in the form of a tube rather than a solid conductor. The thickness of the wall of the tube is not important from an electrical viewpoint, but it must be mechanically strong enough to support itself in the prevailing winds in the location in which it is placed. A one-inch, two-inch or even three-inch pipe may be used, but such a large diameter is not necessary. Hard drawn copper, brass or aluminum tubing may be used.

The length of a half-wave element for a dipole, including two equal sections and a space of one inch between them, is found from the following formula:

$$L = \frac{5540}{F}$$

Where: L is length in inches
F is frequency in mc.

Thus, an antenna for 46.5 mc. would be—

$$L = \frac{5540}{46.5} = 119 \text{ inches long}$$

Allowing for a space of one inch between them, the sum of their lengths is 119-1 or 118 inches. They are equal in length, and so each must be $118/2$ or 59 inches long, or 4' 11" each. One-half or even one inch variation from this in one or both conductors will not make a serious change in antenna characteristics.

Because of the quasi-optic nature of ultra-

INTRODUCING A NEW TYPE OF MULTI-WAVE TUNER

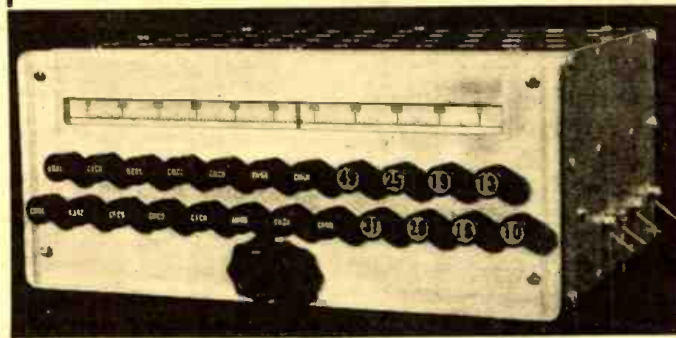

MODEL 142 as illustrated above for superheterodyne circuit—465 kc. wired and tested—complete with instructions, circuit diagrams, charts and other useful data. Patents applied for.

Immediate delivery made upon receipt of order
MICHIGAN RADIO PRODUCTS, Ludington, Michigan PRICE \$15.00 WE PAY THE POSTAGE

A complete frequency coverage in 23 steps. 10 domestic broadcast stations—1700 kc. police band—160 meter amateur band—2400 kc. police band—80 meter amateur band—aircraft—49-31-25-20-19-16-13-10 meter bands and all this by means of push buttons. Guess work in short wave reception is eliminated in that this precision built product is capable of receiving short wave stations with the same facility as stations in the domestic broadcast band.

- No external variable condenser gang necessary.
- No gang switch used.
- No oscillator padding condensers.
- Tuning is positive and smooth.
- Mounted in dust proof metal cabinet.
- Overall dimensions of tuner proper: $9\frac{1}{4}$ " x $6\frac{3}{4}$ " x $4\frac{1}{2}$ ".

high frequencies (tendency to follow only the line of sight and vanish beyond the horizon), the transmitting and receiving antenna should be placed as high as practicable. It is generally possible to install such an antenna about 10 to 20 feet above a roof or 30 to 40 feet above the ground on a wooden pole or iron pipe. Even if the house or ground on which the antenna is to be installed is at a high altitude, it is wise to install the antenna as high as practicable. At a low altitude, it is essential for satisfactory reception.

As long as the distance from the antenna to the set is not more than 30 or 40 feet it will be possible to get satisfactory results, using an ordinary "twisted pair" lead-in. A regular lamp cord protected from the weather by a wax or rubber cover will do. The adjacent antenna ends are connected to these lead-in ends with bolts or by soldering. For distances greater than 40 feet, a coaxial or concentric line should be used.

For the proper impedance match to the dipole with the following dimensions for the inside diameter of the outer conductor, the proper ranges of wire size for the inside conductor are given in the table immediately following.

A	B	C	D
3/8	.375	9	16
7/16	.4375	8	15
1/2	.5	7	14
9/16	.5625	6	12
5/8	.625	5	12
11/16	.6875	4	11
3/4	.75	3	10
13/16	.8125	2	9
7/8	.875	2	9
15/16	.9375	1	8
1	1	1	8

- A = inside diameter of coaxial outer sheath in fractions of an inch.
- B = decimal equivalents of values in column A.
- C = gauge size of inner coaxial conductor wire or tube for 72 ohm impedance.
- D = gauge size of inner coaxial conductor wire or tube for 120 ohm impedance.

Any gauge value between that in column C and that in D will be suitable but the C values are to be preferred. Dimensions and connections for the twisted pair lead-in and the coaxial lead-in are shown in Fig. 1, A and B, respectively.

As in television reception, it is very often

SKY PILOT

World TIME CLOCK
The Only Clock for Universal Use Throughout the Entire World!

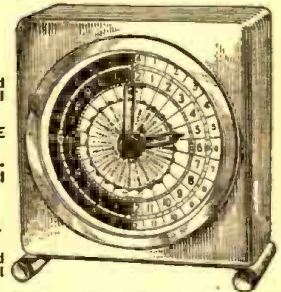

- A REGULAR CLOCK with A.M. and P.M. divided dial
- A WORLD-TIME CLOCK instantly indicating time in all 24 zones
- INTERNATIONAL CLOCK with A.M. and P.M. 24 hour dial

Indispensable for Short Wave Fans. Electric (for A.C. 110-120 volts, 60 cycles) \$9.95

A.M.ATEURS discount 40%
P.P. prepaid in U.S.A.
Remit by check or money order; register letter if you send cash or unused U. S. postage stamps.

GOLD SHIELD PRODUCTS
350 Greenwich St., Dept. RT-941, New York City

USE BUD PANELS AND CHASSIS

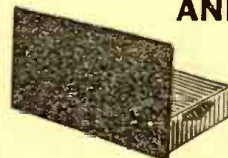

A SIZE FOR EVERY APPLICATION

For ease of construction, handsome appearance and rugged protection, use BUD Panels and Chassis. Write today for your free copy of the new No. 241 BUD Catalog.



BUD RADIO, Inc.
CLEVELAND, OHIO

Do you need BINDING POSTS?



The XL PUSH POST with its Spring Action assures Constant Contact and quick connection. Manufactured in All Aluminum Type M at 12c each. Aluminum Body, Bakelite Top Type B1 at 15c each. Type B1 completely insulated with Bakelite Insulating Shell type C1 at 20c each and drawn by 240 hr Salt Spray Test AS NON CORROSIVE our Types CP or NP at 28c each.

Manufacturers and Dealers Liberal Discounts
X. L. RADIO LABORATORIES
420 West Chicago Ave., Chicago, Ill.

FREE! ONE or ALL of these books

THE publishers of RADIO & TELEVISION give you the opportunity to add three outstanding books to your technical radio library. They make the offer even more attractive by giving these books to you absolutely FREE. A subscription to RADIO & TELEVISION for seven months at the cost of One Dollar gives you a choice of either of the three books shown in this advertisement. For Two Dollars you receive RADIO & TELEVISION for fourteen months and you receive any two books absolutely FREE. To get all three books FREE, enter your subscription for twenty-one months for only Three Dollars.

ANOTHER SAVING FOR YOU—THE PUBLISHERS PAY POSTAGE ON THE BOOK OR BOOKS YOU CHOOSE.

All of the books contain numerous photographic illustrations and diagrams and have stiff, flexible covers.

ABC OF TELEVISION



Contains latest material on television developments. It covers theory of scanning; simple television receiver; how the eye sees; the photoelectric cell; neon lamps; need for broad channel width in transmission of high-fidelity television signals; cathode ray tube and television receivers; Farnsworth system of television transmission, and other important features.

SHORT WAVE GUIDE



Covers hundreds of short-wave questions and answers; illustrates popular short-wave kinks; gives explicit instructions for building simple short-wave receivers; instruction on the best type of antenna installation; diagram and construction details for building transmitters.

S. W. RADIO QUIZ BOOK



This book covers questions and answers on transmitters, short-wave receivers, ultra short-wave receivers; practical kinks, wrinkles and coil winding data; novel hook-ups for experimenters; how to "hook-up" converters, noise silencers, beaters, noise modulators, beaters, modulators, pre-oscillators, antennas, pre-selectors, 5-meter receivers.

RADIO AND TELEVISION, 20 Vesey Street, New York, N. Y. RT-9-41

Gentlemen: Enclosed you will find my remittance of \$..... for which enter my subscription to RADIO AND TELEVISION as checked below; also send me, postpaid, the book or books which I have marked below.

- ABC OF TELEVISION
- S. W. RADIO QUIZ BOOK AND KINKS
- SHORT WAVE GUIDE

- 7 months—\$1.00—choice of any one of three (3) books. (Canadian and foreign—\$1.30)
- 14 months—\$2.00—choice of any two (2) of the three (3) books. (Canadian and foreign—\$2.60)
- 21 months—\$3.00—all three books. (Canadian and foreign—\$3.90)

If you are a subscriber now, we will extend your present subscription.

- New subscriber
- Old subscriber

Name

Address

City

State

Send your remittance by check or money order. If you send cash or unused U.S. postage stamps, please be sure to register your letter for your own protection.

BE A SUCCESSFUL Photographer

America's largest photographic school offers you the full time personal attention of some of the country's leading photographers. Individual. Practical instruction. No classes. Start any time. Resident or home study courses. FREE book gives details. N. Y. INSTITUTE OF PHOTOGRAPHY, Dept. II, 10 West 33 St., New York, N. Y. (31st Year)

desirable to make the receiving antenna have directional characteristics which will make it have an increased sensitivity in the direction of the transmitter. In this way, an ordinary antenna may be made to have 3 or 4 times the response in any given direction. Its pick-up in other directions is, of course, reduced.

Directional properties are given the antenna by means of a reflector *element* placed behind it. This reflector element consists of a single length of the same material of which the antenna is made and is placed parallel to the antenna one-quarter wavelength behind it. Its actual length is about 5% greater than the entire antenna. Its length is found by means of the following formula:

$$L = \frac{5760}{F}$$

Where: L = length of reflector in inches
F = frequency in mc.

Thus, for our chosen frequency of 46.5 mc. we will have—

$$L = \frac{5760}{46.5}$$

$$L = 124 \text{ inches} = 10' 4''$$

This is very close to ½ wavelength, and is used as the length for the reflector. Being placed in parallel with the antenna and back of it ¼ wavelength, we may simply divide 10' 4" by 2 giving 5' 2" as the spacing between the antenna and its reflector. The complete antenna with its reflector is shown in Fig. 1 C. The dotted lines simply indicate a possible wood supporting structure and all dimensions are given. The entire frame with the antenna and reflector as a unit may be mounted so that it may be rotated thus adapting it to the best possible reception for each station. This practice has been very widely developed by amateur operators for both directional transmission and reception.

Antennas A and B of Fig. 1 are non-directional as described but C of Fig. 1 is directional. Its approximate field pattern at resonance is shown in Fig. 2. This polar pattern in a horizontal plane (looking down from the top of the vertical antenna and reflector) shows the relative ability of pick-up of the system in every direction. In direction A, the pick-up is maximum and about 4 times as great as that in direction D. In other directions, such as B, C and E, the pick-up is in proportion to the lengths of these radials from the antenna to the field pattern curve. This field pattern clearly shows the advantage of the directional system.

Connection to the Receiver

Of the numerous methods of coupling a transmission line to a receiver input the most common one is simply an inductive loop or small coil. For the usual F.M. receiver, the antenna coil consists of two turns of heavy wire wound in a ½ inch diameter coil. Sometimes a small series condenser is used in series with a slightly

different coil design so that the input impedance of the set can be more critically matched to the lead-in. A typical detector-oscillator input circuit for an F.M. receiver is shown in Fig. 3. One R.F. amplifier may be found in some designs to provide a little more selectivity and gain. Both the selectivity and gain are improved by such a small extent that R.F. amplifiers at U.H.F. are not in general use. The circuit L2-C1 is tuned to the center carrier frequency to be received—that is, the frequency of the transmitter with no modulation.

To formulate a quick approach to the determination of the grid to ground impedance of this or any following grid tuned circuit for an R.F. amplifier, we can proceed as follows:

In seeking an expression for the shunt resonant impedance of such a circuit in terms of its L, C and R values, we start with the impedance as we have found it to be in former work—

$$(1) Z = \frac{(2\pi f)^2 L^2}{R} \text{ or}$$

$$\frac{4\pi^2 f^2 L^2}{R}$$

Which does not include the capacity term. At resonance, we know that the capacity reactance XC is equal to the inductive reactance XL and instead of squaring XL as above, we may achieve the same result by multiplying XL and XC. This gives—

$$(2) Z = \frac{XLXC}{R} \text{ or, using the expres-}$$

sions for reactance,

$$Z = \frac{2\pi f L \times \frac{1}{2\pi f C}}{R}$$

$$Z = \frac{2\pi f L}{R}$$

$$(3) Z = \frac{L}{RC} \text{ which is the shunt impedance including the capacity term.}$$

Without going any further, we can now see that the impedance is greatest for the highest possible values of inductance, and the lowest possible values of "series" resistance and capacity. We cannot make the capacity lower than a minimum determined by the distributed capacity of the coil and circuit and we cannot reduce the resistance below the minimum due to the R.F. resistance of the coil. From the basic formula—

$$(4) f = \frac{1}{2\pi \sqrt{LC}}$$

we know that for any definite frequency

the product (LC) can have only one numerical value. At a frequency of 46.5 mc. this value may be found to be—

$$(5) LC = .000011765 \times 10^{-12}$$

with—L in henries
C in farads

We cannot hope to reduce the capacity of this circuit much below 3 mmfd. if we can achieve this minimum value. Assuming that we can, it is obvious that L cannot exceed—

$$L = \frac{.000011765 \times 10^{-12}}{3 \times 10^{-12}}$$

$$(6) L = .0000039216 \text{ henries or } 3.9216 \text{ microh.}$$

Now, if we express C in terms of L from (5) as—

$$C = \frac{.000011765 \times 10^{-12}}{L}$$

we can substitute this value for C in (3), obtaining—

$$Z = \frac{L}{.000011765 \times 10^{-12} \times R}$$

$$Z = \frac{L^2}{.000011765 \times 10^{-12} R}$$

$$(7) Z = \frac{85.100 L^2 \times 10^{12}}{R}$$

and placing the maximum value of L at 3.9216×10^{-6} henries whose square is 15.3×10^{-12} henries approximately in (7) we have finally—

$$Z = \frac{85.100 \times 15.3 \times 10^{-12} \times 10^{12}}{R}$$

$$(8) Z = \frac{1,302,000}{R}$$

With these conditions in mind, we have reduced the problem to one of determining the R.F. series resistance of the circuit. Due to the nature of coils at high frequencies and other factors such as coupling impedances and tube impedances, it is not likely that R can be reduced much below 200 ohms. This value would give from (8)—

$$Z = \frac{1,302,000}{200}$$

$$Z = 6,501 \text{ ohms}$$

The gain of any amplifier stage may be found quite accurately by multiplying the transconductance of the tube in *micromhos* by the load impedance in *megohms* of the tube. With such low impedances as above,

the accuracy of this method is increased. Thus a tube having a Gm of Sm of 2000 micromhos and a load of .006501 meg. would have a gain of $2000 \times .006501$ or 13.03.

Practically all of the conditions which we have just considered represent the limiting values of best design. It is rarely possible to achieve these conditions in practice, and never possible to achieve them over any considerable tuning band. Consequently, the usual gain which we may expect of an U.H.F. amplifier is from 2 to perhaps 8.

(End of Part I)

Articles on Frequency Modulation

In past Issues of this Magazine

- A Frequency Modulation "Converter"—R. Muniz, E.E., and J. Haddad—June, 1940.
- Frequency Modulation—R. Muniz, E.E., and J. Haddad—July, 1940.
- Hints on Operating the "F.M." Receiver—R. Muniz, E.E., W. Oestreicher—Aug., 1940.
- Principles of Frequency Modulation—R. Muniz, E.E.—Aug., 1940.
- Principles of Frequency Modulation—R. Muniz, E.E., Part 2—Sept., 1940.
- Building the Browning "Frequency Modulation"—G. H. Browning—Oct., 1940.
- Frequency Modulation "Tuner"—to Suit Your Pocketbook—Larry LeKashman and Anton Schmidt—Oct., 1940.
- A Frequency Modulation Tuner—Herman Yellin—Dec., 1940.
- A "Pull-Swing" Frequency Modulation System for the Amateur—R. Muniz, E.E., Donald and Warren Oestreicher—Feb., 1941. [Also March, April and May, 1941.]
- Principles of Frequency Modulation—F. L. Sprayberry—Feb., 1941.
- An U.H.F. Receiver for FM and AM—S. Gordon Taylor—Feb., 1941.
- F-M Receiver for the Home—L. M. Dezzettel—March, 1941.
- Principles of Frequency Modulation—Part 2—F. L. Sprayberry—March, 1941.
- Principles of Frequency Modulation—Part 3—F. L. Sprayberry—April, 1941.

Television Articles

In past Issues of Radio & Television

- New Portable Television Pickup—Sept., 1940.
- 10 by 8 Inch Television Images—Television Club, Brooklyn Tech. High School—Oct., 1940.
- Amateur Television Made Practical by New Image Pickup Tube—Aug., 1940.
- A Semi-Portable Television Receiver—R. H. Horn—Jan., 1941.
- Television Travels 190 Miles Over Wires—Mar., 1941.
- Interference Phenomena in Television Reception—Thornton Chew—April, 1941.

SAVE UP TO 50% FACTORY-TO-YOU



9 BANDS (ON 6 DIAL SCALES)

20 TIMES EASIER FOREIGN TUNING with SUPER BAND SPREAD RADIO!

PUT THIS CHASSIS IN YOUR PRESENT CABINET

\$19.75 COMPLETE with SPEAKER, TUBES, PUSH-BUTTON TUNING, MAGNA TENNA LOOP AERIAL—READY TO PLAY

UP TO 50% TO TRADE-IN

THINK OF IT... 20 TIMES EASIER TO TUNE... 10 TIMES MORE SENSITIVE THAN ORDINARY RADIOS! Crystal Clear High Fidelity Tone. Famous 30-day trial plan fully protects you and enables you to prove Midwest's powerful new 1942 Super Spread Band performance in your own home, without obligation, as thousands of people every day are doing. Write today. Your name on a 1¢ postal card will do.

WRITE FOR BIG FREE 1942 CATALOG SHOWING RADIOS, RADIO PHONOS, HOME RECORDERS FROM \$11.95 to \$121.00 UP TO 16 TUBES

9 BAND CONSOLE \$43.95 COMPLETE **30 DAYS TRIAL** **E-Z TERMS**

MIDWEST RADIO CORPORATION
DEPT. 24-B CINCINNATI, OHIO

SHORT WAVE CONVERTERS for CAR RADIOS



Can be attached to any car radio.
MODEL 600-A covers 49-31-25-20-19 and 16 meter bands. Designed for American and Foreign short wave broadcast. Distance range 5,000 to 10,000 miles. List Price... \$24.95
MODEL 700 long wave covers 135 to 410 KC. Receives gov. weather reports, etc. List Price... \$24.95

Models 600-A & 500-A shown.
List Price \$12.50
MODEL 800 Super Sensitive police converter with fixed condenser. Covers 1500 to 2500 kc. Two metal tubes, exceptional distance range. List Price... \$15.95
MODEL 200 with variable condenser, covers 1530 to 6000 kilocycles. List Price... \$17.95
MODEL 500-A with variable condenser and illuminated dial covers 1000 to 6000 kc. Very sensitive, has two metal tubes. Exceptional distance range. List Price \$21.95
Jobsbers and Dealers Wanted

ABC RADIO LABORATORIES 3334 N. New Jersey St., Dept. RT-9, Indianapolis, Ind., U.S.A.

RADIO ENGINEERING DEGREE IN 2 1/2 YEARS

Complete Radio Engineering Course in 27 months. Bachelor of Science Degree. Radio (television, talking pictures and the vast electronic field) offers unusual opportunities for trained radio engineers. Courses also in Civil, Electrical, Mechanical, Chemical, Aeronautical Engineering; Business Administration and Accounting. Tuition, living costs low. Recognized by War Department for training of radio operators. Special preparatory department for those who lack required high school work. Students from all parts of the world. Enter September, January, March, June, 58th year. Write for catalog, 2491 COLLEGE AVE., ANGOLA, IND.

TRI-STATE COLLEGE

NEW! 1941 MODEL! POCKET RADIO!
NO TUBES NO BATTERIES NO PLUG-IN DURABLE PLASTIC CABINETS



DUAL BANDS—MAGICTENNA—MICRODIAL. Fits your pocket or purse—Wt. 6 ozs. Small as cigarette package. Receives standard and some short wave. PATENTED POWER RECTIFIER. No tubes, batteries. Hi-ratio easy tuning slide "MICRODIAL."
M. L. OF ILL. SAYS: "MIDGET RADIO WORKS FINE!"
ONE YEAR SERVICE GUARANTEE.
Sent complete ready to listen with instructions & tiny phone for use in homes, offices, hotels, in bed, etc.
SIMPLE TO OPERATE—NO ELECTRICITY NEEDED!
SEND NO MONEY! Pay postman only \$2.00 plus postage charges on arrival or send \$2.99 (Check, M.O., Cash) and yours will be sent postpaid. A MOST UNUSUAL VALUE! ORDER NOW! FRET PLUG IN "MAGICTENNA"—ELIMINATES OUTSIDE WIRES!
MIDGET RADIO CO., Dept. RT-9, Kearney, Nebr.

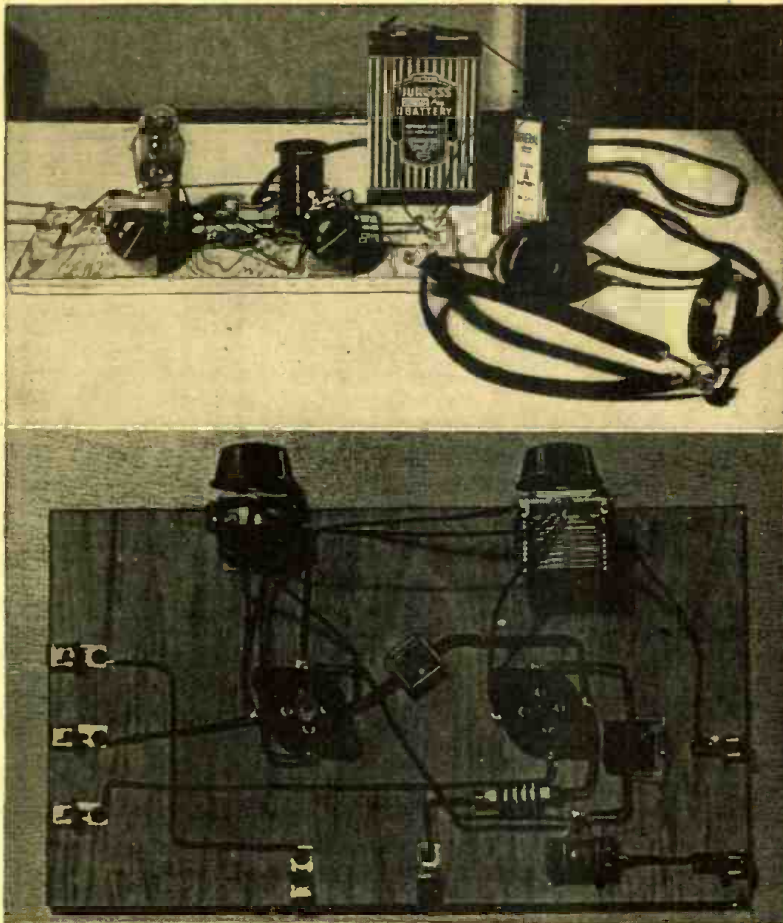

Front and top views of the one-tube receiver.

For Beginners

The Old Reliable One-Tube Receiver

L. M. Dezettel, W9SFW*

The one-tube receiver will probably live "forever" so far as radio beginners and short-wave enthusiasts are concerned. Both broadcast and short-wave stations can be tuned in on this set. It is battery-operated.

● WE were surprised but very much gratified to see so many inquiries come in for the circuit of a simple one-tube receiver. This indicated to us that many young fellows are just becoming interested in radio, with the thought perhaps of possibly fitting into the demand for communications men in our National Defense Program.

It would have been easy for us to refer these young fellows to any one of many previous RADIO & TELEVISION issues for a circuit of this type, but believing that there may be many young fellows equally interested, but who just haven't written us, we decided to publish the circuit of a simple one-tube battery-operated receiver. Although the receiver we are about to describe uses only one tube, you will be surprised at the wonderful results that can be obtained with it. Standard plug-in coils are used, covering the wavelengths from the top of the broadcast band down to $9\frac{1}{2}$ meters. With a good antenna and under proper atmospheric conditions, it is easy to pick up many of the principal foreign short-wave broadcast stations.

All Parts Numbered

Let's look at the circuit. Notice that each of the parts in the schematic diagram is numbered to correspond with the same part in the pictorial diagram. This helps you identify and learn the schematic symbols used to represent the various parts in the circuit.

The 30 tube is used in socket 6. Although this tube is rated at 2 volts at the filament, it operates perfectly on a $1\frac{1}{2}$ volt "A" bat-

tery. This tube has been on the market for a number of years, but it performs in this circuit every bit as well as any of those with the more modern tube type numbers.

A 50,000 ohm potentiometer is used for regeneration control. Its effect is to act as a variable "short circuit" on the tickler winding of the coil. Tuning is accomplished by the variable tuning condenser No. 4. Its capacity is 140 muf.

A list at the end of the article designates each part that is used in this receiver, together with the numbers that correspond to the diagrams. The prices of the accessories will vary according to the quality of the headphones purchased and the size of the batteries. Be sure that you have all of the necessary parts on hand, before beginning the assembly of this receiver.

Only 3 Tools Needed

The only tools required are a long-nosed plier with side cutters, a screwdriver and a soldering iron. For making the soldered connections use resin core solder, or regular solid solder with separate resin paste. *Never use acid when soldering.*

We start the assembling of the set by mounting the variable condenser and potentiometer brackets to the front edge of the board. Then mount the Fahnestock clips around the other three edges as shown in the pictorial diagram. The two four-prong wafer sockets are mounted $\frac{1}{2}$ " above the board by means of spacer bushings. Be sure that the large holes in the sockets are facing in the direction shown.

Wiring should be done neatly with short, direct connections from one point to an-

other. SHORT connections are most important when operating the set on the higher frequencies. Connections to the Fahnestock clips are made by pushing back about $\frac{1}{2}$ " of the insulation on the hook-up wire and wrapping the wire once around the wood screw before it is tightened down. All other connections are soldered. In soldering, after the connection is hooked over the terminal, apply the soldering iron to the connection and hold it there until the connection is hot enough to flow the solder. Use only very small amounts of solder and resin—only enough to flow into the connection and make a good bond with the terminal.

Recheck the Wiring

When you have finished wiring, it is a good idea to check back over the diagram. Take a colored crayon or pencil and draw over each of the connections on the diagram as you check your wiring. This will eliminate the possibility of having overlooked any of the connections.

Now let's try out our set. First we must have a good antenna. One that is about 75 or 100 feet long, including the lead-in, is about right. The aerial itself, which can be made of regular No. 14 solid or 7x22 stranded wire, must be suspended between insulators as high up in the air as possible. The lead-in, consisting of a rubber covered wire, connects to one end of the antenna and comes down over the side of the house to the receiver. If possible, keep this lead-in away from the house by using stand-off insulators.

The ground may consist of a good clean

*Engineer, Allied Radio Corp., Chicago, Ill.

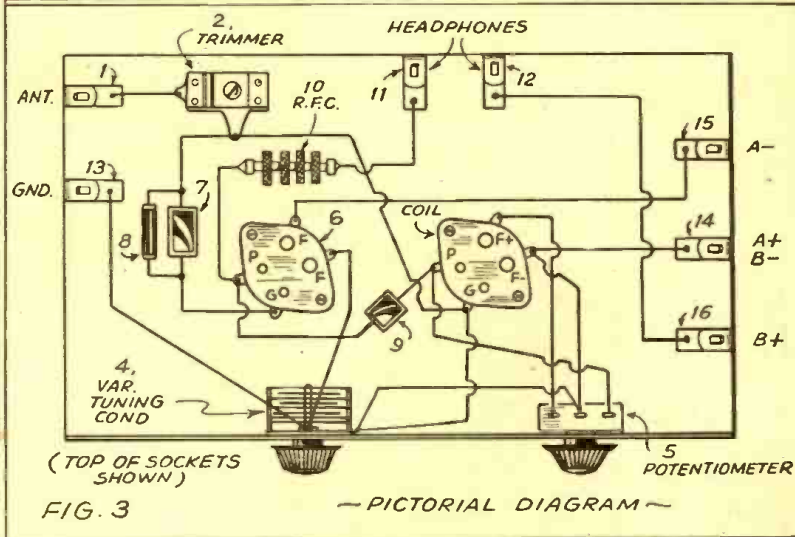
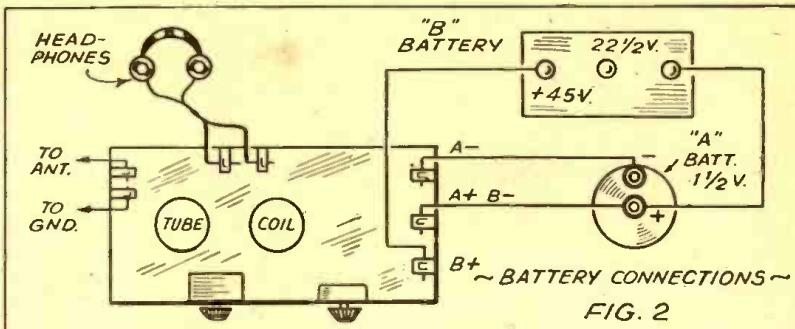
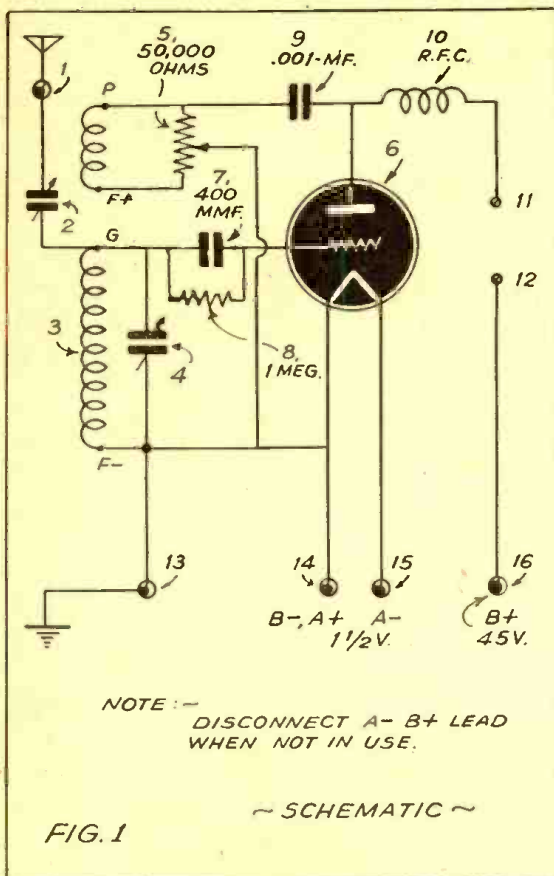

Wiring diagram for the one-tube receiver.

connection to any cold-water pipe or to a rod about six feet long driven into moist ground. The headphone should be any good make of 2000 ohms impedance or higher. A standard 45 volt "B" battery and a connector for it, and a 1½ volt "A" battery complete the accessories.

First connect the headphones and the "A" battery only. You should see a faint glow in the tube. In fact, this glow is so faint that it requires a darkened room to see it. Now connect the "B" battery as shown in figure No. 2. As the connection is made from the plus 45 volt terminal on the "B" battery to the "B" plus Fahnestock clip (No. 16) a very loud click should be heard in the headphones.

With a broadcast coil in the socket on the right, and the antenna and ground connected, advance the potentiometer until several chirps are heard as you revolve the variable tuning condenser (No. 4). Carefully tune in one of these heterodyne notes and (by turning the control knob to the left) reduce the potentiometer setting. A point will be reached where the heterodyne will soon stop and the music or voice is loudest. This point, at which the heterodyne whistles just begin or just end, depending upon which way the potentiometer knob is turned, is called the *critical point of oscillation*. It is at this point that the set has its greatest sensitivity and selectivity.

Now, you will find that the trimmer condenser (No. 2) has a great deal of effect upon the operation of the set, especially at the highest frequencies. If the screw on the trimmer condenser is turned to the left too far, the receiver will not have the sensitivity that it should, but its selectivity or

ability to tune out stations will be greater. If the screw on the trimmer condenser is turned to the right too far, the volume of the signals will increase but the selectivity of the receiver will become less and the receiver may stop oscillating. Adjustment of this trimmer condenser must be made by experiment, and will depend upon your own desire as to type of operation. You will find that it generally requires readjusting for each change of coil. The usual method of adjustment is to make it as tight as possible, and yet not tight enough to prevent the set from oscillating. After a little experience you will find that this adjustment is an easy matter.

Tuning in Short-Wave Stations

Naturally, you are anxious to try out the receiver on the *short-wave* band. If you are trying this set for the first time during the evening, plug in a coil which includes 49 meters. This is usually the best band for night-time DX reception from foreign countries. Tuning for short-wave stations requires a great deal more care than for local broadcast stations. The regeneration control should be turned up to the critical oscillation point. If there is no station which will identify this point, you can usually hear a low thud as you reach it.

Now, *slowly*—VERY SLOWLY—rotate the variable tuning condenser until the characteristic heterodyne whistle of a station is heard. Keep this station tuned in and very carefully, back down on the potentiometer until the whistle just stops. Don't be surprised if the announcer has an English accent. It is as easy as rolling off a log to tune in London, or Berlin, or an

innumerable number of South American stations, as well as many in the United States.

The writer shall be pleased to describe, from time to time, any other radio or electronic unit for which the greatest number of requests are received from RADIO & TELEVISION Magazine readers. Don't hesitate to let your needs be known, and we'll see what we can do for you.

Parts List

- No. 1—Fahnestock clip
 - No. 2—3.35 mmf. mica trimmer condenser
 - No. 3—4 prong wafer socket
 - No. 4—140 mmf. midget tuning condenser
 - No. 5—50,000 ohm potentiometer
 - No. 6—4 prong wafer socket
 - No. 7—.0004 mf. mica condenser
 - No. 8—1 megohm ¼ watt grid leak resistor
 - No. 9—.001 mf. mica by-pass condenser
 - No. 10—2.1 mh. radio frequency choke
 - Nos. 11, 12, 13, 14, 15, 16—Fahnestock clips
- Also—
- 2—Round knobs
 - 2—Supporting brackets, Knight B5288
 - 1—Package hardware, Knight N2928
 - 1—Pair headphones, 2000 ohms or higher
 - 1—Type 30 tube
 - 1—45 volt "B" battery
 - 1—1½ volt "A" battery
 - 1—Connection clip for "B" battery
 - 1—Set of two coils covering broadcast band
 - 1—Set of four coils covering 9.5 to 217 meters

Tell the Editors
What Kind of Articles
YOU Like—
We'll Try to Please

Diagrams of Interest

This is a new department. If you have a new Hook-Up, send it along; a pencil diagram will do. Be sure to include a brief description.

All diagrams and descriptions accepted and published will be awarded a year's subscription. Diagrams may be for receivers, adapters, amplifiers, etc. Send them to Hook-Up Editor, RADIO & TELEVISION, 20 Vesey Street, New York City.



FLIGHT THE PICTORIAL FLYING REVIEW

Brings you all the phases of world aviation and aeronautics in a non-technical yet educational manner—exciting articles which catch your breath, yet give you the fundamentals of flying and ALL related subjects. FLIGHT keeps you abreast of all the major developments as fast as they appear anywhere.

Now, when planes and flying are of vital importance to all, you just can't do without this highly absorbing yet instructive publication. You must be "in the know."

Partial Contents of Sept. Issue:
 Radio Conquers Bombers—by Hugo Gernsback. Can New York Be Bombed? Giant Sikorsky Flying Boat. The Blackburn-Skua. Helicopter Problem Solved—by Igor Sikorsky. The Russian Air Force! The Junkers JU 86K Bomber. Versatile R.A.F. "Lysander." "Blackburn" Botha Torpedo Plane. Why Planes Need "Air Brakes." Radio Beam Locates Planes. Build Your Own "Flight Trainer!"

Attractive three-color cover, numerous illustrations. **15¢** copy. Send 10¢ for a Sample Copy.

Subscription price \$1.50 a year, Canada and foreign \$2.00.

FLIGHT MAGAZINE, 20-T Vesey St., New York, N. Y.

RADIO AND ELECTRONIC DICTIONARY Containing 3,800 Definitions



THIS RADIO AND ELECTRONIC DICTIONARY, written by Harold P. Manly, explains the meaning of 3,800 words used in radio, electronics and other closely allied fields. It includes new terms used in radio transmission, sound pictures, television, public address, aviation radio, navigation and industrial control, photo-electricity, photocell application, telephotography, etc. This dictionary permits learning every new expression whether you hear it or read it. Alphabetically arranged for quick reference. 550 illustrations augment definitions in the text.

The book is recommended for students, instructors, engineers, service men, experimenters, salesmen and everyone in any way associated with radio. **ONLY \$2.50**

BOOK OF ITS KIND—HANDY—EASY TO USE—AND TIMELY. The RADIO AND ELECTRONIC DICTIONARY is new, authentic and printed in a single volume of 300 pages, size 6 x 9 inches. The book weighs two pounds, and bound in durable cloth. SHIPPED ANYWHERE **\$2.50** IN U. S. A. POSTPAID.

Mail remittance by check or money order to

RADIO PUBLICATIONS

20 VESEY STREET NEW YORK, N. Y.

RADIO EVERYTHING IN RADIO

This one big book serves your entire radio needs. It includes sets, parts and supplies, public address systems, amateur equipment, testers, kits and fluorescent lighting. You'll find the nationally known favorites at the lowest possible prices. Get your copy of this big FREE CATALOG today.

BURSTEIN-APPLEBEE COMPANY
 1012-14 MCGEE STREET, KANSAS CITY, MISSOURI

BASS BOOSTER

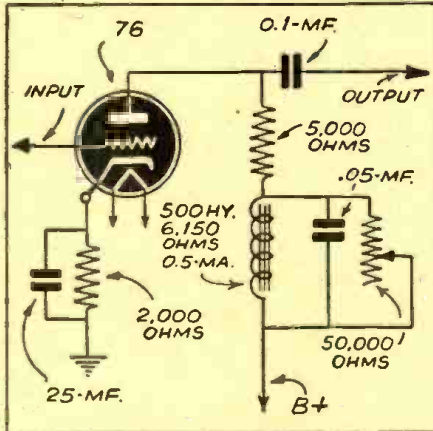

PICK-UP CIRCUIT

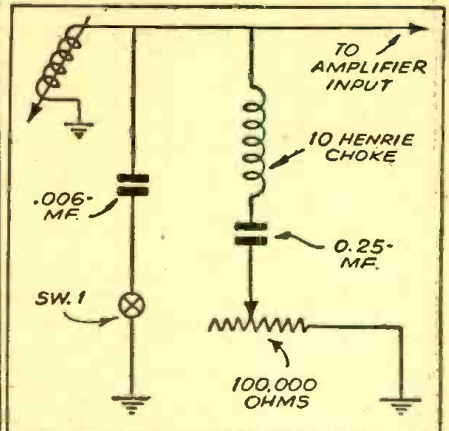

The diagram here shows simple bass booster suggested by David Steele. He states that this circuit works very well indeed and is simple and inexpensive to build. The point of best response is determined by the capacity of the condenser across the choke; this may be about .05 mf. and several other condensers may be arranged with a switch.

Carl Lindgren contributes the circuit shown here with for an improved pick-up arrangement. He states that a superior tone is obtained with it. He employs a 10 henry choke and a .25 mf. tubular condenser, together with a .006 mf. tubular condenser connected as indicated. With SW1 closed the audio range is somewhat higher.

CODE PRACTICE OSCILLATOR

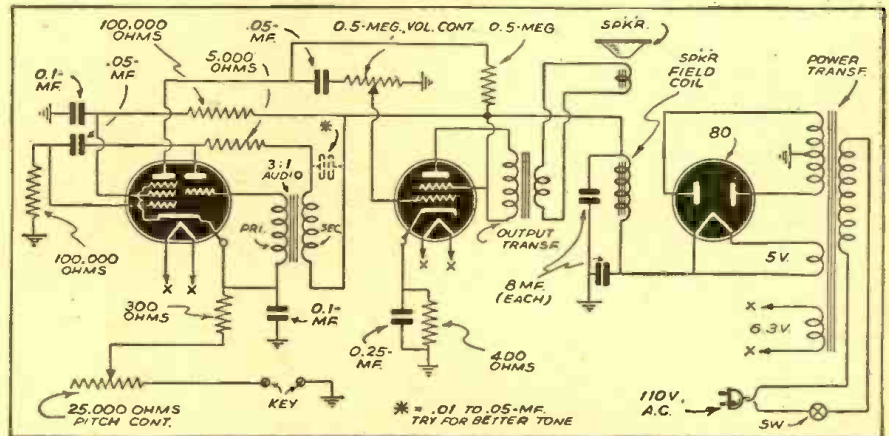

Here is an improved code practice oscillator with loudspeaker operation, suggested by Howard H. Arnold, engineer at Broadcast Station KFJB, Marshalltown, Iowa. This circuit provides good tone and variable pitch. A small condenser connected across the secondary winding may improve the tone.

WHAT IS WRONG WITH THIS DIAGRAM?

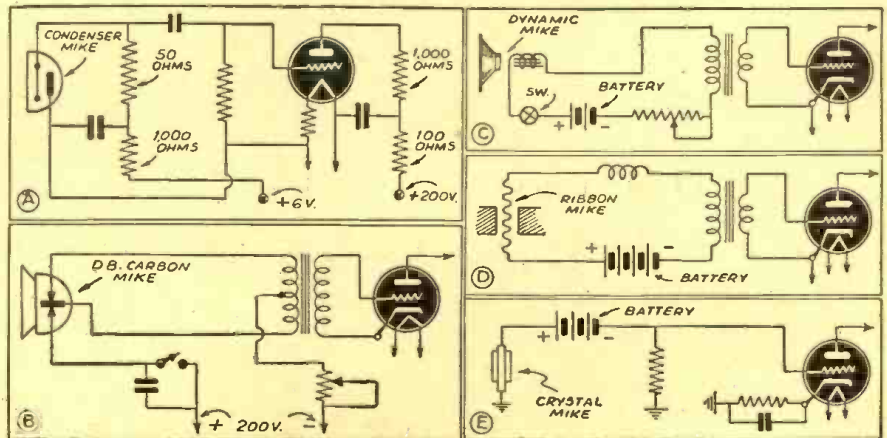

Study this diagram at least three minutes before turning to the answers on page 320.

to the Radio Experimenter

THREE-IN-ONE RECEIVER

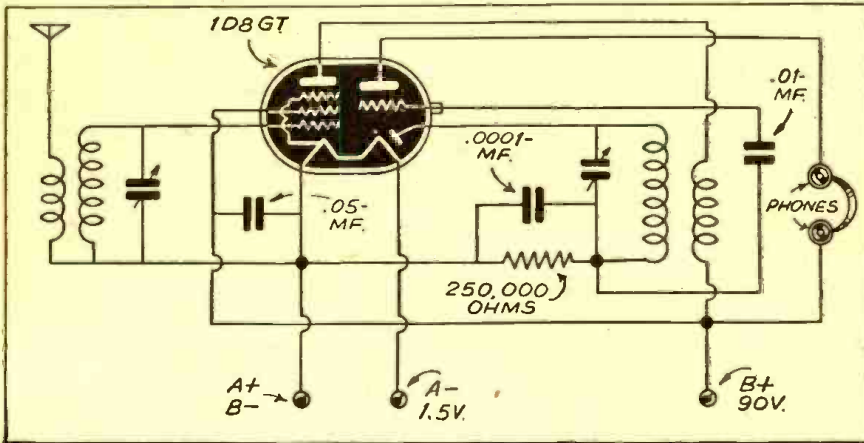

This receiver circuit, suggested by John L. Belfi, will be of interest to radio experimenters as it permits one tube to perform three functions. The 1D8GT is a diode-triode-pentode. The pentode section is used as an R.F. amplifier and the diode serves as a detector, with the triode unit working as an audio amplifier. The two variable condensers are ganged; the value depends upon the coils used.

A.C.-D.C. POWER SUPPLY

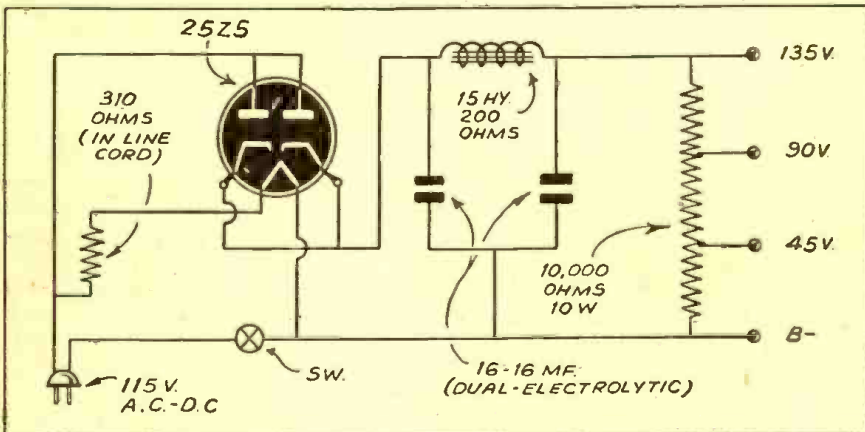

Here is a handy power-supply for experimenters and one that does not require a power transformer. It was suggested by John L. Belfi and most of the components came from a discarded midget receiver. Instead of the 25Z5 a 117Z6GT could be used, thus eliminating the 310 ohm line cord. The output current is 50 ma.; the highest voltage indicated will be a little lower if the unit is used on 110 volts D.C.

2½ METER TRANSCEIVER

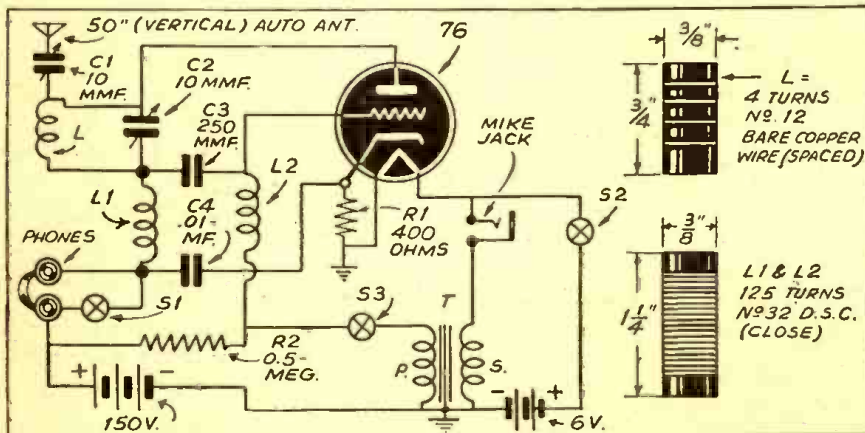

This handy transceiver circuit was suggested by Bob Bassett. Coil data is given in the diagram as well as the condenser and resistor values. 2,000 ohm head-phones are used. A single-button carbon mike may be used.

GEOPHYSICAL PROSPECTING PRINTS (TREASURE FINDERS)



50c EACH

BLUE PRINTS and INSTRUCTIONS

For Building the Following Treasure Finders and Prospecting Outfits

- Folder No. 1. The "Radioflector Pilot"—consists of a 2-tube transmitter and 3-tube receiver. Principle: radiated Wave from transmitter loop is reflected back to receiver loop. Emits visual and aural signals.
- Folder No. 2. The "Harmonic Frequency Locator"—Transmitter radiates low frequency wave to receiver, tuned to one of Harmonics of transmitter. Using regenerative circuit. Emits aural signals.
- Folder No. 3. The "Beat-Note Indicator"—Two oscillators so adjusted as to produce beatnote. Emits visual and aural signals.
- Folder No. 4. The "Radio-Balance Surveyor"—a modulated transmitter and very sensitive loop receiver. Principle: Balanced loop. Emits visual and aural signals. By triangulation depth of objects in ground can be established.
- Folder No. 5. The "Variable Inductance Monitor"—a single tube oscillator generating fixed modulated signals and receiver employing two stages R.F. amplification. Works on the inductance principle. Emits aural signals.
- Folder No. 6. The "Hughes Inductance-Balance Explorer"—a single tube Hartley oscillator transmitter and sensitive 3-tube receiver. Principle: Wheatstone bridge. Emits aural signals.
- Folder No. 7. The "Radiodyne Prospector"—a completely shielded instrument. Principle: Balanced loop. Transmitter, receiver and batteries enclosed in steel box. Very large field of radiation and depth of penetration. Emits aural signals.

With any one of the modern geophysical methods described in the Blue-Print patterns, radio outfits and instruments can be constructed to locate metal and ore deposits (prospecting); finding lost or buried treasures; metal war relics; sea and land mines and "duds"; mineral deposits; subterranean water veins; oil deposits (under certain circumstances); buried gas and water pipes; tools or other metallic objects sunken in water, etc., etc.

Each set of blueprints and instructions enclosed in heavy envelope (9½" x 12½"). Blueprints 22" x 34"; eight-page illustrated 8½" x 11" fold. 50c or of instructions and construction data. Add 5c for postage

The complete set of seven folders \$3.00 Shipping weight 2 lbs. (add 25c for shipping anywhere in U.S.A.)

TECHNIFAX

1917 S. STATE ST. CHICAGO, ILL.

TECHNIFAX 1917 So. State, Chicago, Ill.

Enclosed herewith \$..... for which mail to address below:

Treasure Finder No. 1, 2, 3, 4, 5, 6, 7. Complete set of seven folders.

NAME

ADDRESS

CITY STATE RT-941

Edited by Herman Yellin, W2AJL

Simple Superhet Circuit

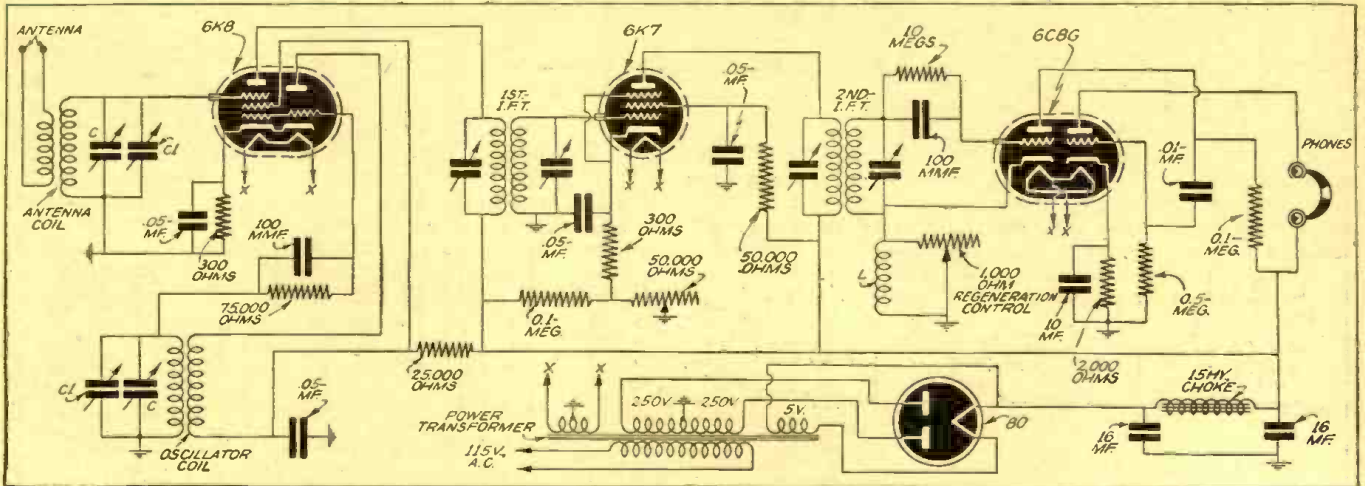

Simple Superhet receiver circuit, provided with regeneration in the second detector. No. 1259.

? Please print a diagram of a simple superhet having a regenerative I.F. stage.—M. Kardaic, New York City.

A. In the superhet shown, both the R.F. and oscillator coils can be of the commercially available plug-in type. Condensers 'C' are 140 mmf. units for band-setting, while condensers 'C-1' are 25 mmf. units for band-spread at any portion of the frequency spectrum. Regeneration is obtained in the second detector by means of the 75-turn coil 'L', consisting of number 30 wire, jumble-wound, on a 1/2 inch diameter form. Regeneration is controlled by the 1000 ohm potentiometer shunting this coil. The 6C8G tube functions as both the second detector and one stage of audio, allowing ample volume for headphone reception. If desired, an additional stage of audio can be added, using a 6F6 or 6N6G, thereby permitting the use of a loud-speaker.

Power-Supply Hook-up

? Please publish a diagram of a power-supply for a short-wave receiver, using a 6C5, 6F6 and 6J7 tubes.—S. Bea, Valdosta, Ga.

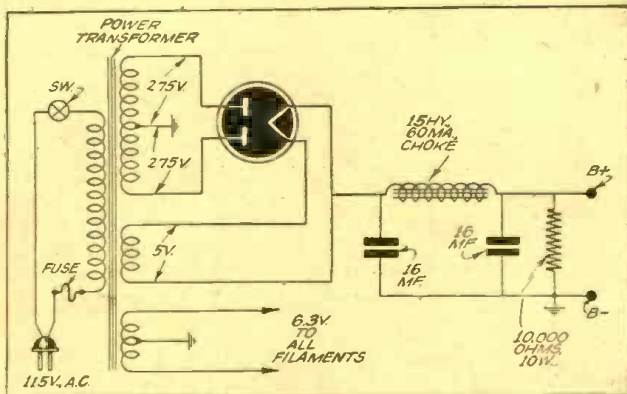

Power Supply for S-W receiver. No. 1260.

A. Shown here is a diagram using an 80 or a 5Y3G tube as a rectifier. The filter condensers should be of the 400 volt rating. If a tapped resistor of the slider type is used, instead of the fixed resistor shown in the diagram, the output voltage may be varied.

Phono-Oscillator Hook-up

? I was very much interested in the diagram of the phono-oscillator using a 117L7GT shown on page 50 of the May issue, but was wondering how plate voltage was supplied to the oscillator plate.—P. H. Klein, Chicago, Ill.

A. Due to a slight error, the diagram was incorrectly shown. The center tap of the oscillator coil should have been connected to the junction of the 500 ohm and 1 megohm resistors, and the 8 mf. condenser at the coil center tap should have been omitted.

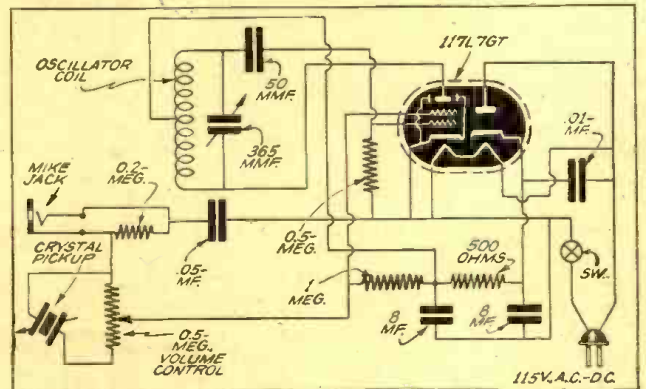

Corrected Phono-Oscillator Hook-up. No. 1261.

"Little Nipper" Conversion

? Re. the article on converting the "Little Nipper" to battery tube operation, there seems to be an error in the second detector section of the diagram.—R. Braidwood, Vancouver, B. C.

A. Unfortunately, a slight error crept into the diagram of the article on page 728 of the April, '41 issue. A corrected diagram is shown here of the second detector section. The other parts of the diagram are correct.

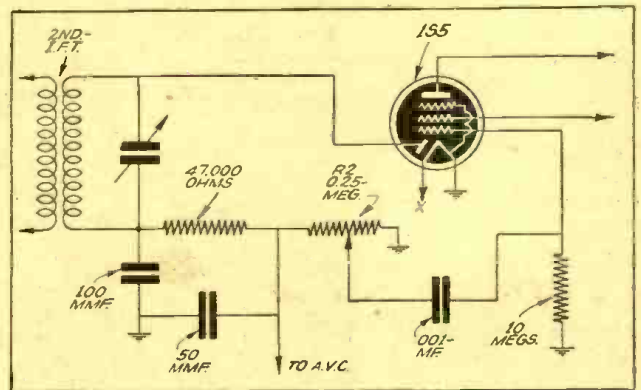

Diagram for converting "Little Nipper" to battery operation. No. 1262.

Queries to be answered by mail (not on this page) should be accompanied by fee of 25c (stamps, coin or money order). Where schematic diagram is necessary, our fee is 50c up to 5 tubes; for 5 to 8 tubes fee is 75c; over 8 tubes, fee is \$1.00. No picture diagrams can be supplied.

Condenser for Superhet

? What size tuning condenser is used in the 5-tube superhet receiver shown on page 536 of the January issue?—H. Weissman, N. Y.

A. The tuning condenser is a special dual unit (365 mmf.) condenser. The oscillator section has specially cut plates to track properly with the loop used with this receiver. If a standard 2-gang condenser is used, it will be necessary to redesign the oscillator circuit to make use of a series padder for proper tracking.

Tunable Hum

? I am experiencing difficulty with tunable hum on my A.C. operated regenerative receiver. Is there any way to eliminate this?—J. J. Woulfe, N. Y.

A. Try bypassing the filament to ground with a .01 mf. condenser. Also you may have to bypass the high voltage power-supply with a good paper or mica condenser of about .005 mf. Make sure its rating is for the voltage used.

Impedance-Matching Problem

? How can I match a low-impedance output transformer to a 5000 ohm load in a transmitter?—H. Quin, East Orange, N. J.

A. Assuming by low impedance output you mean about 8 ohms, it would be necessary for you to use another transformer having an impedance of 8 ohms, and an output impedance of 5000 ohms. You could use a standard 5000 ohms output transformer, operated backwards, although it would be more efficient to use a single transformer of the correct impedance.

Mike Amplifier

? How can I use the F.M. Hi-Fi amplifier described in the January issue as a mike amplifier?—F. Jelinek, N.Y.C.

A. Since the original amplifier has insufficient gain to operate from a crystal mike, it will be necessary to add a pre-amplifier stage. This may consist of a 6J7, such as is diagrammed below and can be constructed on the same chassis as the main amplifier, or as an auxiliary unit. This pre-amp. can be added to any low-gain amplifier, or the amplifier of a radio set, to enable microphone operation from the unit. The rotor of the volume control can be connected either to the input terminal of the main amplifier, or directly to the grid.

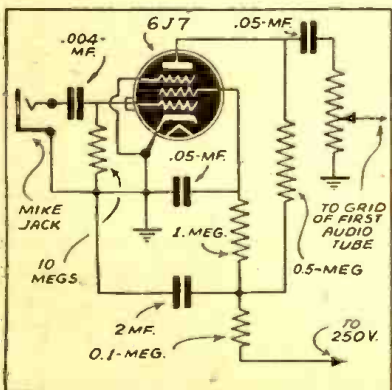

Signal Generator

? I intend to construct the all-wave signal generator described in the May 1940 issue, but would like to eliminate the push-buttons and make provision for visual alignment.—G. B. Thomas, Georgetown, Br. Guiana, S. A.

A. The push-buttons can be replaced by a double-pole rotary switch having six positions. It is not necessary to use the elaborate dial shown in the original model. If you

use a 2526 rectifier, you will have to rewire the filaments for series operation and I presume you would like to eliminate the power transformer. This will reduce the available plate voltage but should in all probability prove satisfactory. The input jack connected across the tuning condenser is for the purpose of connecting a frequency wobblator for use in visual alignment. A built-in frequency wobblating device, either electronic or mechanical, would require a complete redesign of the entire unit and so would be impractical.

DON'T FAIL TO GET THIS

SHORT WAVE COIL DATA BOOK

Every experimenter knows that the difference between a good and a poor radio set is usually found in the construction of short-wave coils. Coil winding information is vitally important and in the new coil book all "dope" appears. There're illustrations which give instructions on how to wind coils, dimensions, sizes of wire, curves and how to plot them. Every experimenter needs this book—it also contains complete data on all types of receiving coils, together with many suitable circuits using these coils. Also complete data on various types of transmitting coils with many transmitting circuits such as exciters and amplifiers using the various coils described.

Contents Briefly Outlined
 S-W Tuning Inductance Charts • Coil Data for T. R. F. Receivers • One Tube Oscillodyne • Two Tube Bandspreader • The Mono-Coil • 2-Tube Old Reliable • 3-Tube Globe Trotter • 2 Winding Coils—10-300 Meters • Doerle • 3-Tube "Signal Gripper" Electrified • 3-Tube Bandspreader for the Ham • General Coverage Coils on Ribbed Forms • Coil Data for Superhet or S-W Converter • Ultra S-W Coils • Switch Coils for S-W Superhets • Experimental Coils • S-W Antenna Tuner • Most Popular S-W Tuning Circuits • Self-Supporting Transmitting Circuits Employing Coils Described • All Band Antenna Tuner for Transmitting • Plug-in Coils for Exciters • Frequency-Wavelength Conversion Chart.

PRICE 25c PREPAID
 For a copy of this handy book send 25c in U.S. Coin or stamps to

RADIO PUBLICATIONS
 20 VESEY STREET NEW YORK, N. Y.

FREE!

with \$1.00 subscription to

RADIO & TELEVISION

FULL LIBRARY SIZE

MODERN WEBSTER DICTIONARY

416 PAGES

CONTAINS: 22,000 DEFINITIONS • DICTIONARY OF RADIO WORDS AND TERMS • DICTIONARY OF THE AUTO-MOBILE • TABLES, TREATISES, ETC.

FLEXIBLE IMITATION LEATHERETTE COVER, SIZE 5 1/2" x 8"

FILL OUT—MAIL THIS COUPON TODAY!

RADIO & TELEVISION, 20 Vesey Street, New York, N. Y.

Gentlemen: Enclosed you will find One Dollar for which enter my subscription to RADIO & TELEVISION Magazine for Eight Months. Send me, ABSOLUTELY FREE and POST-PAID, my copy of the MODERN WEBSTER DICTIONARY.

This is a New Order Extend my Present subscription

Name

Address

City State RT-941

(Remit by check or money order; register letter if you send cash or unused U.S. Postage Stamps)

If you will take advantage NOW of our special subscription offer of eight months for \$1.00, we will send you ABSOLUTELY FREE and POST-PAID this 416 page full library size MODERN WEBSTER DICTIONARY—useful and instructive to everyone. This self-pronouncing authoritative dictionary—a new work throughout—contains the most up-to-date words now in common use. 22,000 definitions in all. It also features a Glossary of Radio Words and Terms, Dictionary of the Automobile, Treatises on Practical Syntax, Etymology, Punctuation and Standard English by well known authorities, Metric Tables, Time, State Flowers, National Parks of the U. S., etc.

This is a time limited offer, so don't delay in returning the Coupon.

RADIO & TELEVISION

20 VESEY STREET NEW YORK CITY

First Prize EASY KEY ACTION

Finding that my heavy duty key was too hard to press down comfortably, even when the spring was adjusted as loosely as possible, I remedied the problem by loosening the spring completely, so that it no longer had any effect on the key and hooked a small rubber band around the far end of the key. By using the proper size rubber band and placing it near the contact adjuster, the key operates nicely.—Roy Hempel.

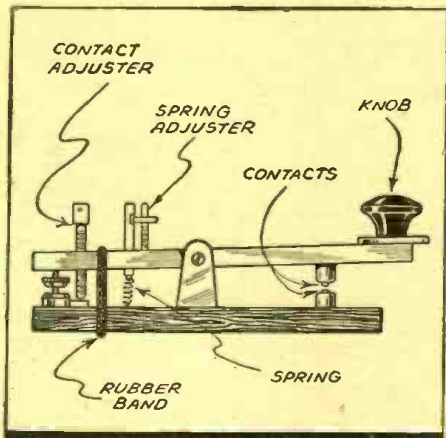

NOVEL USE FOR SOCKETS

As wafer sockets are cheaper than bakelite, I used them for breadboard layouts in the following way. Invert the socket and the tube in the opposite ends of the socket holes.—Arthur W. Crampton, Jr.

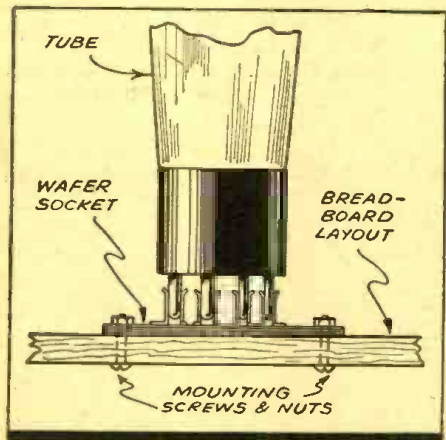

"PERSONAL" PICK-UP

When you do not wish to disturb anyone yet wish to listen to records you can very

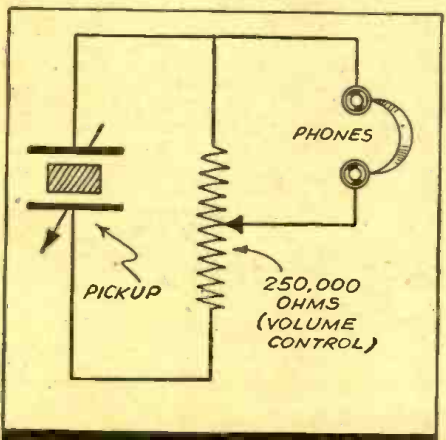

easily hook up the following diagram. On the softer end of the volume control the bass notes will be emphasized.—Arthur W. Crampton, Jr.

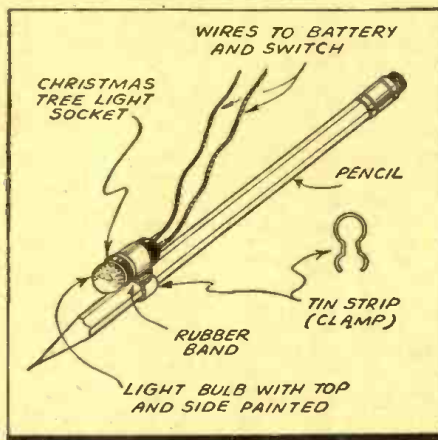

HANDY PENCIL LIGHT

An idea that someone may find useful is this small light hooked up to the end of a pencil. The diagram is self-explanatory except for the fact that the light bulb is partly painted, to keep the light out of the operator's eyes. I used a small bottle of bronze enamel, ready mixed, which I secured from the hardware store for ten cents. The pencil can be easily slipped out of the clamp when desired. The combination light and pencil can be used for such things as an aid in making drawings, writing in poor light, peering into small nooks and crannies, and—if properly hooked up—as a handy pocket "circuit tester."—Roy Hempel.

SIMPLE CIRCUIT TEST

I recently installed a talk-back system between a garage and office, a distance of about 100 yards and the wires were already strung between the two buildings but there was no means of distinguishing the leads, so I used the following method to locate the proper leads.

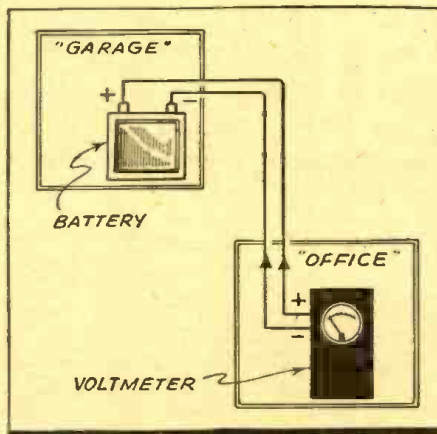

I connected a 22.5 volt battery across the leads in the garage and then used a voltmeter in the office to check for polarity of the leads in the office and in this way I

was able to distinguish the respective wires.—B. W. Embree.

HUM PREVENTER

This kink will help to eliminate hum being transmitted through a radio chassis from a transformer or choke. Rubber plumbing washers are mounted on either side of the screw securing the foot of the transformer to the chassis. In fact, one of the washers can be placed directly under the foot, so as to prevent direct conduction of the core vibrations to the chassis.—Franklin Williams.

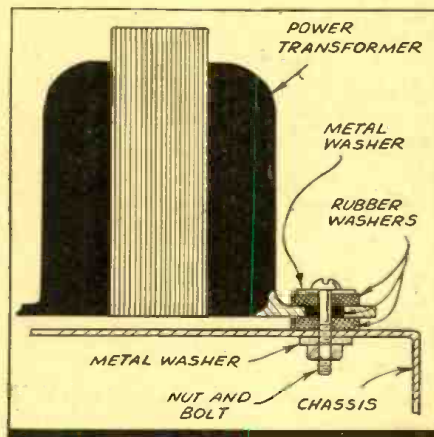

SPEED CONTROLLER

Here is an excellent resistor to control speed of small 110 volt A.C. or D.C. motors.

Obtain an old fruit jar (with metal lid) and cut out the top of this lid, leaving only a narrow rim. Cover this rim with a fibre disc and mount two binding posts, so that the binding posts are insulated from the metal top and also from each other. One binding post is connected to a metal disc in the bottom of the jar with an insulated wire. The other post is connected to a slide through which a metal rod can slide to a desired position. On the end of this metal rod is another metal disc which may be moved up or down in the jar. Put a suitable handle on the upper part of the rod and fill the jar with salt water. The water rheostat is then ready for use.—Jim Suder.

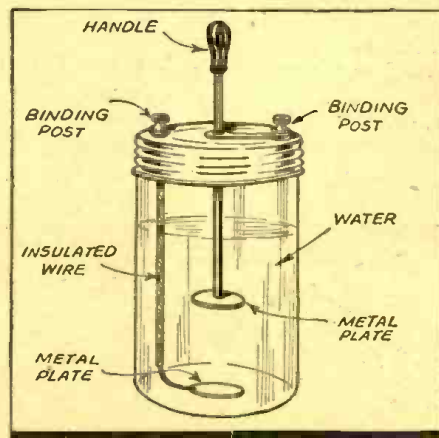

RADIO KINKS

published on these pages will win their senders 8 months' subscription to RADIO & TELEVISION. The best kink published each month will win a 2 years' subscription. Read these kinks; they will be of real use to you, besides indicating what is wanted. Send a typewritten or ink description with sketch of favorite to the Kink Editor

SOLDERING KINK

Have you ever tried to solder without an iron, alcohol lamp, or blow torch when these were not available? Wrap plenty of rosin core solder around the joint to be soldered, and wrap it quite tightly. Then apply the heat from your matches or candle. Caution—be sure you use rosin-core solder.—James Limbeck.

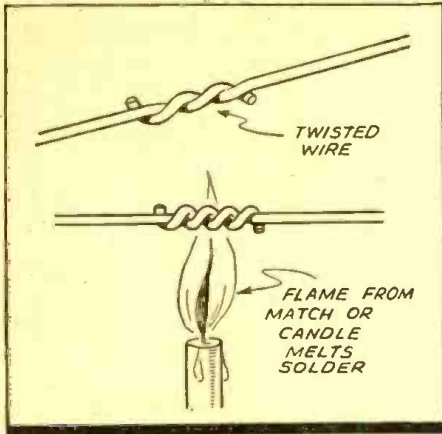

SIMPLE SCREW DRIVER

A simple screw driver can be easily secured by taking a key that is found on most coffee cans and filing the end down smoothly.—Roy Hempel.

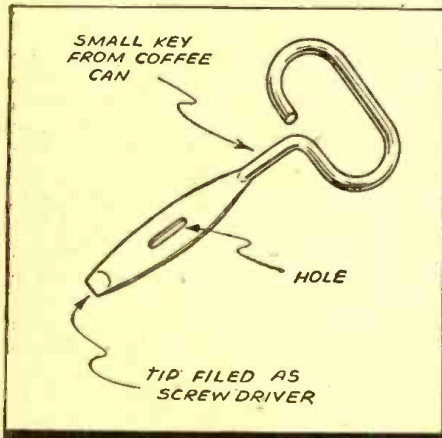

SHOCK-PROOF PLIERS

Cut pieces of rubber hose a little longer than the handle, and put some rubber cement in one end of the piece. Next squeeze the end and hold until it is dry.—Fred Larmie.

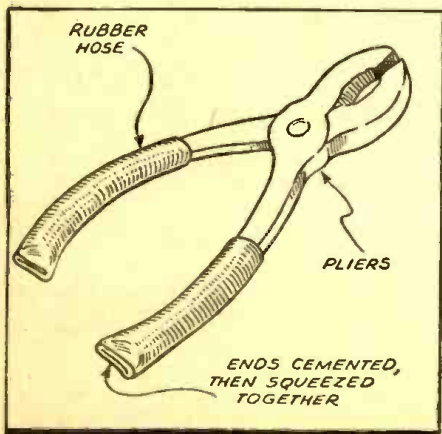

● IT IS always the well-trained man who wins out over the horde of thousands of superficially trained and incompetent men. You are reading this magazine because you are interested in radio. Sooner or later, the time will come when you will wish to cash in on your knowledge. You also realize that, at the present time, there are many branches of the radio art which you do not know as thoroughly as you should. Knowledge, these days, can be gotten cheaper than

AMERICA'S BEST RADIO BOOKS

ever before. It isn't necessary for you to go to college to become proficient in radio. Start today, to build a REAL radio library and become acquainted with all branches of this great and growing art. In this page are listed the world's best radio books. We have combed the market for the really important books in radio, so that, no matter what branch you are interested in, you can pick out the best books that are now printed.

We present the most complete collection of recent important radio books. We have, after an exhaustive study, selected these volumes because they represent the foremost radio books of their kind in print today. There is such a great variety that we are sure it will satisfy any taste as well as any requirement that the student of radio might have. We publish no catalog and ask you to be kind enough to order direct from this page. Prompt shipments will be made to you direct from the publishers. We merely act as a clearing house for a number of radio publishers and OUR PRICES ARE AS LOW OR LOWER THAN WILL BE FOUND ANYWHERE. Remit by money order or check. Register all cash.

HOW TO BUILD RADIO RECEIVERS. Paper covers, 8x11", profusely illustrated, 168 pgs. Price prepaid **60c**

Grade A construction articles on many devices including a "wireless" phono oscillator, signal tracer, hi-fi P.A. tuner, etc.

MARCONI—THE MAN AND HIS WIRELESS. by Orrin E. Dunlap. Cloth covers, 6x8 1/2", illustrated, 360 pgs. Price prepaid **\$3.50**

This is the life-story of Marconi. It is divided into 5 parts dating from 1874 to 1937. A story every radio man should know.

CATHODE MODULATION. by Frances C. Jones. Stiff paper covers, 8 1/2 x 11", well illustrated, 96 pgs. Price Prepaid **\$1.00**

The description of an economical system of radio transmitter modulation, by its inventor, of especial interest to ham-radio operators.

POLICE COMMUNICATION SYSTEMS. by V. A. Leonard. Cloth covers, 5 1/2 x 8 1/2", illustrated, 390 pgs. (with a chapter on radio legislation); and a Bibliography. Price prepaid **\$5.00**

The present head of the Police Communication system at Ft. Worth, Tex., comprehensively describes every phase of modern police-radio.

THE LIE DETECTOR TEST. by Wm. Moulton Marston. Cloth covers, 8x8", 8 illus., 182 pgs. Price Prepaid **\$2.00**

What is a Lie Detector? How does it work? These and many other questions are answered in detail by a capable author.

HOW TO MAKE GOOD RECORDINGS. Board covers, 5 1/2 x 8", well illustrated, 128 pgs. Price Prepaid **\$1.25**

No owner of disc sound recording equipment should be without this book, which tells how to make records at home, add sound to silent home-movies, etc.

THE RADIO AMATEUR'S HANDBOOK. 8th Edition, by A. Frederick Collins. Cloth covers, 5 1/2 x 8", well illustrated, 342 pgs. Price prepaid **\$2.00**

A practical and easily-understandable guide to radio construction and repair, complete with schematic and picture diagrams.

RADIO OPERATING. QUESTIONS AND ANSWERS. 7th Edition, by Arthur R. Nilson and J. L. Hornung. Cloth covers, 5x8", well illustrated, 416 pgs. Price Prepaid **\$2.50**

This entire book is in the form of questions and answers on obtaining Government radio licenses. Covers radio theory and practice.

PRINCIPLES OF TELEVISION ENGINEERING. by Donald G. Fink. Cloth covers, 6x9", 318 illus., 541 pgs. Price prepaid **\$5.00**

American Practice in the design, construction and use of television transmitters and receivers, presented in text-book style.

DEMONSTRATION EXPERIMENTS IN PHYSICS. edited by Richard Manly Sutton. Cloth covers, 6x9", 408 illus., 545 pgs. Price Prepaid **\$4.50**

A compilation of 1,200 Experiments, especially suitable for high schools and colleges, designed to demonstrate the principles of (radio) physics.

ELECTRON OPTICS IN TELEVISION. by I. G. Maloff and D. W. Epstein. Cloth covers, 6 1/2 x 9 1/2", profusely illustrated, 299 pgs. Price prepaid **\$3.50**

This book develops the theory of optics and its most useful application—the television cathode-ray tube.

RADIO FREQUENCY ELECTRICAL MEASUREMENTS. 2nd Edition, by Hugh A. Brown. Cloth covers, 6x9", profusely illustrated, 384 pgs. Price prepaid **\$4.00**

A useful manual on test procedure for the practicing engineer, as well as for the technically-minded radio amateur and experimenter.

RADIO ENGINEERING. 2nd Edition, by Frederick Emmons Terman. Cloth covers, 6 1/2 x 9 1/2", well illus., 814 pgs. Price prepaid **\$5.50**

A University Professor presents a comprehensive engineering treatment of the more important radio vacuum-tube phenomena. A "must".

THEORY OF VACUUM TUBE CIRCUITS. by Leo James Peters. Cloth covers, 6x9", 110 illus., 256 pgs. Price prepaid **\$3.00**

A standard school textbook on the fundamentals of triode vacuum-tube circuits. To know radio circuits, read Peters.

RADIO PHYSICS COURSE. 2nd Enlarged Edition, by Alfred A. Ghirardi. Cloth covers, 7 1/2 x 9 1/2", 510 illus., and numerous tables, 510 pgs. Price Prepaid **\$4.00**

Most recommended general reference book on radio. Embryo as well as advanced radio men are urged to put it in their library.

RADIO & ELECTRONIC DICTIONARY. compiled by Howard P. Manly. Cloth covers, 6x9", 550 illus., 280 pgs. Price prepaid **\$2.50**

Defines 3,800 words and terms used in Radio (including sound movies, television, public address and electronics).

PRINCIPLES OF RADIO COMMUNICATION. by J. H. Morecroft. Cloth covers, 6x9 1/2", profusely illus., 988 pgs. Price prepaid **\$7.50**

This radio classic presents in exceptionally lucid style the elements of the entire radio art. Second to no book in its class.

TELEVISION. by V. K. Zworykin and G. A. Morton. Cloth covers, 6x9", profusely illustrated, 648 pgs. Price Prepaid **\$6.00**

All the most intimate details of electronic television transmission and reception, as practiced today, are bared for technicians.

ORDER DIRECT FROM THIS PAGE

PRINCIPLES OF RADIO. 3rd Edition, by Keith Henney. Cloth covers, 5 1/2 x 8", 311 illus., 458 pgs. Price prepaid **\$3.50**

This book starts with Ohm's Law and winds up discussing television. On the way it presents detailed information on Radio's principles and instrumentalities.

SHORT WAVE DIATHERMY. by Tibor de Cholnoky. Cloth covers, 6 1/2 x 9 1/2", well illustrated, 310 pgs. Price prepaid **\$4.00**

The principles and practice of Radio Diathermy are set into in great detail. The design of equipment and its use are discussed.

RADIO OPERATORS' LICENSE GUIDE. 2nd Edition, by Wayne Miller. Paper covers, 6x9", illustrated, 158 pgs. Price Prepaid **\$3.00**

Over 1,250 acceptable answers to questions based on the F.C.C.'s new "6-element" quiz for amateur or commercial licenses.

WE PRESENT TELEVISION. edited by John Porterfield and Kay Reynolds. Cloth covers, 6x9", 43 illus., 298 pgs. Price prepaid **\$3.00**

The comprehensive and easily-readable writings of a group of television technicians, each expert in a particular subject.

FOREIGN POSTAGE

For foreign countries, please remit in addition to the above prices the following amounts for postage:—
Up to 1.00—10c
Up to 2.00—15c
Up to 3.00—25c
Up to 5.00—35c

HOW TO ORDER

We cannot ship C. O. D. Our prices are net, as shown. Books sent prepaid in U.S. only.

THEORY AND APPLICATIONS OF ELECTRON TUBES. by Herbert J. Reich. Cloth covers, 6 1/2 x 9 1/2", completely illustrated, 670 pgs. Price Prepaid **\$5.00**

Students are given a thorough grounding in electron tube principles, associated circuits and equipment. A "final authority".

TELEVISION BROADCASTING. by Lenox R. Lohr. Cloth covers, 6 1/2 x 9 1/2", 88 illus., 274 pgs. Price Prepaid **\$3.00**

The status of radio, remote, and film television, is described. Recommended to everyone in television.

LOOK AND LISTEN. by Milton B. Sleeper. Durable spiral flexible binding, 6x9 1/2", over 100 illus., 96 pgs. Price prepaid **\$1.00**

Cloth binding **\$1.50**
A handbook on television as of April, 1939 (when 441-line scheduled telecasting started).

TELEVISION AND SHORT-WAVE HANDBOOK. by F. M. Camm. Cloth covers, 5 1/2 x 8", 130 illus., 272 pgs. Price prepaid **\$2.50**

Principles and practices of the foremost television systems, presented in simplified descriptions, circuits and picture diagram.

RADIO PUBLICATIONS 20-T Vesey St., New York, N.Y.

Construction and Operation of A Slide-Wire Bridge

John L. Belfi

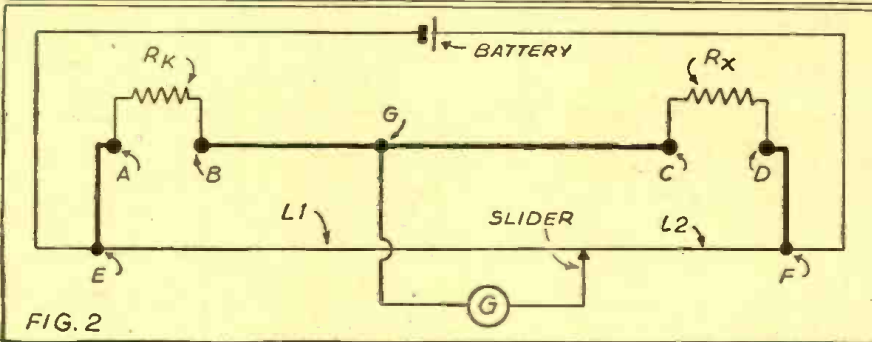
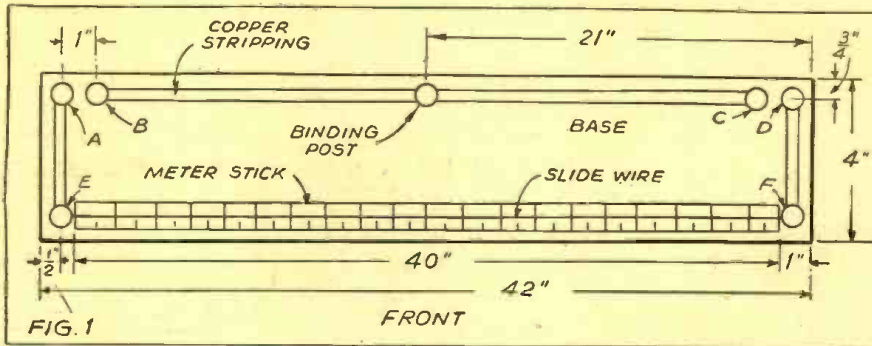

This bridge will be found useful and of low construction cost.

● THERE are many times when the need for an accurate resistance measuring device arises. The only instrument which answers to this requirement is the *bridge*. Commercial bridges are very expensive and the average experimenter invests his money in apparatus which has more utility. A bridge which is usually overlooked because of its bulkiness is the *slide-wire* bridge. This bridge can be constructed simply and inexpensively, yet it is as accurate as any other bridge. It can also be used for measuring inductors and capacitors, as well as resistances. This bridge should be made a part of every experimenter's equipment.

The materials required for the construction of the bridge proper are, a piece of wood 42" long, 4" wide and 3/4" thick, a thin strip of copper or brass 4' long and 1/2" wide, seven metal binding posts, 4' of high resistance wire, and a graduated meter stick. The latter may be obtained at any science supply house. These measurements need not be exactly as indicated, but it is important that the bridge be laid out symmetrically.

The base is cut to the proper size and the edges are beveled slightly. A coat of shellac is then applied. The meter stick is now screwed down in the position shown in Fig. 1. The screws are put through the meter stick, but be careful not to cover up any of the numbers. Remember that the numbers should be facing you when you are looking at it from the position marked "front" in the diagram. The copper strips are next laid out and the binding posts fastened over them to keep them in place. It may be necessary to use screws as well as binding posts to keep the strips from rattling. The high resistance wire is then stretched along the surface of the meter

stick, drawn tight, and fastened permanently to the bottom of the two binding posts. A slider is now needed to slide along the wire. This can be made out of any piece of copper or brass. The only requirements are that it should have a knife-like edge for accuracy. I used No. 24 Nichrome for the slide wire.

This bridge may be operated either as an A.C. or a D.C. bridge. If a galvanometer or an 0.1 milliammeter is available it is recommended that it be operated as a D.C. bridge. For A.C. operation an audio source such as a high frequency buzzer or an audio frequency oscillator is required.

In either case, standard resistances will be required. By a standard resistance we mean one whose value is accurately known. These resistances may either be bought or wound by hand with high resistance wire. If the bridge is to be operated as an A.C. bridge the standard resistances must be *non-inductive*. Remember that the accuracy of your readings will depend upon the accuracy of your standard resistances. A given standard resistance (sometimes referred to as the *known* resistance) can only be used to measure unknown resistances within a certain range. For example, a standard resistance of 10 ohms can only be used to measure unknown resistances ranging from .01 to 1000 ohms. Therefore it is recommended that a set of standard resistances be made available.

First, we will discuss the operation of the D.C. bridge. The standard, or known resistance, R_k , is connected between A & B. The resistance to be measured, R_x , is connected between C & D. A dry cell is connected across E & F. It is recommended that a pushbutton be connected in series with the battery to prevent draining the

battery while making adjustments and calculations. One terminal of the galvanometer, or 0.1 milliammeter, is connected to G, and the other to the slider. Now we are ready to measure the unknown resistance. (Head-phones may also be used instead of galvanometer.—Editor)

The slider is brought in contact with the high resistance wire and the deflection on the meter is noticed. (A center scale instrument is convenient, but not essential.) The slider is then slid along the wire in one direction. If the needle moves further away from zero, the slider must be moved in the opposite direction. The object is to find the point on the wire where the meter reads zero. When this condition is attained the bridge is said to be balanced. When the bridge is balanced, the reading on the meter stick in centimeters just below the slider, is taken. For example, it may be 23 or 66 centimeters. This distance should be read from the left end of the meter stick and is designated L_1 . The distance from the right end is now noted and called L_2 . (See Fig. 2.) Since the length of the meter stick is 100 centimeters, L_2 can be readily found by subtracting L_1 from 100. (Both L_1 and L_2 must be expressed in the *same* denomination, either inches or centimeters.) The following proportion is now formed:

$$\frac{R_k}{R_x} = \frac{L_1}{L_2} \quad (1a)$$

Or, when solved for the unknown resistance, R_x :

$$R_x = \frac{R_k \times L_2}{L_1} \quad (1b)$$

An example will make the above clearer. Let us assume that we have connected the bridge as shown and are using a 10 ohm standard resistance at R_k . The slider is touched to the wire and the needle on the meter moves to the right of zero. We move the slider along the wire towards F and find that the needle swings still further to the right. Consequently, we move the slider towards E. The needle moves back towards zero and then moves to the left of zero. This means that we have passed the point of balance and we move the slider slowly back towards F. Finally we find the point where the meter reads zero (or no sound is heard in the head-phones when the circuit is interrupted by lifting the slider). Looking directly below the slider we see that the reading on the meter stick is 72 centimeters. We put down on a piece of paper, $L_1 = 72$. Subtracting this from 100, we find that $L_2 = 28$. We know that the standard resistance, R_k , equals 10 ohms. Substituting into the formula (1b) we get:

$$R_x = \frac{28 \times 10}{72} = \frac{280}{72} = 3.88$$

Performing the indicated arithmetic we thus find that $R_x = 3.88$ ohms. That is the value of the *unknown* resistance.

SUPER SPECIALS

For A.C. operation a high frequency buzzer is connected in series with the battery, or an audio oscillator is connected in place of the battery. In both cases, the meter is replaced by a pair of headphones. The slider is moved until no sound is heard in the headphones. The bridge is then balanced, and the above procedure is followed. Because of stray capacities it is usually impossible to find a point where the noise will be eliminated entirely, hence the slider must be adjusted for *minimum* response. Because it is more difficult to distinguish between slight differences in volume than in indications on a meter, the A.C. bridge is not as accurate as the D.C. bridge. It is, however, sufficiently accurate for most purposes.

The A.C. bridge can also be used to measure *inductance and capacity*. Of course, standard inductances or capacitors, as the case may be, must be used in place of standard resistances. For capacities, however, it must be remembered that the proportion is an inverse one. That is:

$$\frac{C_k}{C_x} = \frac{L_2}{L_1} \quad (2a)$$

Or, when solved for Cx, the unknown capacity:

$$C_x = \frac{C_k \times L_1}{L_2} \quad (2b)$$

In conclusion let me state that this type of bridge is of straight-forward design, such as is used in many laboratories. There is nothing tricky about its construction or operation, and no difficulties should be encountered by anyone.

"A HI-LOW LAMP"

A Hi-Low lamp is useful in the nursery, bedroom, living room, etc., where a light dimmer may be required at times. Any table lamp, floor lamp, or bed light may be converted by the following method.

Remove the lamp cord and switch now in use. Replace the switch with a Single-Pole, Double-Throw toggle one, of the type used in radio sets. The lamp cord is replaced with a radio *line cord resistor* of about 300 to 360 ohm resistance. Connect as shown.

When the toggle switch is thrown to one side, the light will be bright, as usual. On the other side, the line cord resistor is brought into use and the light will glow dimly, making an excellent night light.—*H. R. Wallin.*

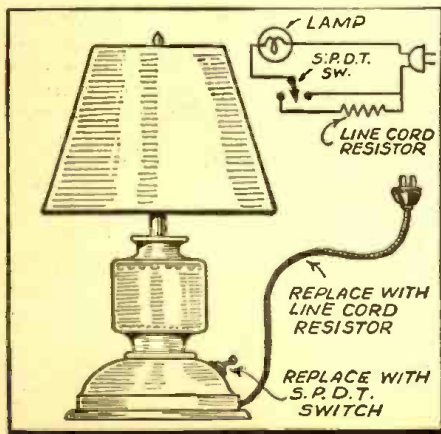

All of the attractive items listed here are brand new. ALL are in PERFECT WORKING ORDER. In many cases, the parts alone total more than the price we are asking. 100% satisfaction guaranteed or your money refunded. ORDER FROM THIS PAGE. Use the convenient coupon below. Include sufficient extra remittance for parcel post charges, also order shipped express, collect. Any excess will be refunded. C.O.D. shipments require 20% deposit. If full remittance accompanies order, deduct 2% discount. Send money order, certified check, new U. S. stamps. No C.O.D. to foreign countries.

ORDER TODAY LIMITED QUANTITIES PROMPT SHIPMENTS ASSURED

VARIABLE SPEED UNIVERSAL MOTOR

FOR 110 VOLTS. A.C. OR D.C.
Made for Dictaphone machines by American Gramophone Co. Used, but in excellent condition. Special lever control permits variable speeds up to 3000 r.p.m. 1/4" shaft extends from both sides of motor. Measures 7 1/2" x 3 1/4" diam. overall. Shp. Wt. 2 1/2 lbs.

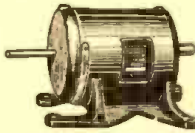

ITEM NO. 11
YOUR PRICE \$1.55

POWERFUL ALL-PURPOSE INDUCTION MOTOR

IDEAL FOR EXPERIMENTERS—101 USES
Sturdily constructed to precision standards, this self-starting shaded pole A.C. induction motor is powerful enough for a large variety of uses. Some of these are: Automatic Timing Devices, Current Interrupters, Electric Fans, Electric Chimes, Window Displays, Photocell Control Devices, Electric Vibrators, Small Grinders, Buffers and Polishers, Miniature Pumps, Mechanical Models, Sewing Machines, Phonograph Motors, Coffee Grinders, Motion Picture Projectors, Motorized Valves, Sirens, and other applications. Consumes about 15 watts of power and has a speed of 3,000 r.p.m. When geared down, this sturdy unit will constantly operate an 18-inch turntable loaded with 200 lbs. dead weight—THAT'S POWER!
The motor is of midsize dimensions, 3 inches high by 2 inches wide by 1 1/2 inches deep; has 4 convenient mounting studs; shaft is 1/8" long by 3/16" diameter, and runs in self-aligning, oil-retaining bearings; the best materials, perfect Precision assembly and rigid inspection certify to its high quality, and assure long life. Designed for 110-20 volts, 50-60 cycles, A.C. only.
ITEM NO. 147
YOUR PRICE \$1.29

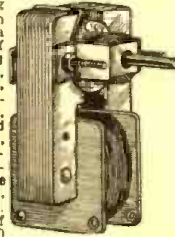

AMAZING BLACK LIGHT!

Powerful 250-Watt Ultra-Violet Bulb
The best and most practical source of ultra-violet light for general experimental and entertainment use. Makes all fluorescent substances brilliantly luminescent. No transformers of any kind needed. Fits any standard lamp socket. Made with special filter glass permitting only ultra-violet rays to come through. Brings out beautiful opalescent hues in various types of materials. Swell for amateur parties, plays, etc., to obtain unique lighting effects. Bulb only. Size of bulb. Shp. Wt. 1 lb.
ITEM NO. 87
YOUR PRICE \$2.00



WELDING! BRAZING! SOLDERING!

3-IN-1 PORTABLE ELECTRIC TORCH

WORKS FROM 110 VOLTS A.C. OR D.C. LINE
This electric torch is not a gadget or a toy but a sturdily built outfit using the finest materials. With it you are able to do professional type of welding, brazing and soldering work, regardless of whether or not you've had previous experience. It will do a thousand and one jobs: tender welding, auto body repairs, bumpers, cylinders, tanks and industrial repairs—ideal for steel fitters, plumbers, sheet metal jobs, engineers, maintenance men, radio and bicycle repair men, etc. Works on aluminum, brass, copper, iron, steel and other metals.
The 3-in-1 electric torch is so simply constructed that even a boy can operate it after reading the simple and concise instructions furnished with the unit. Not necessary to know how to strike an arc! All you do is plug the torch into the light socket, adjust the carbons per instructions, and presto—you have an intense, blazing flame, ready for work. The outfit comes complete with power unit, electric cord, electrode holder, carbons, welding rods, brazing rods, solder flux, goggles, and instructions.
Save money! Do your own repairing. Earn money by doing repairing for others. Simple, practical, durable and safe to handle—that's why the price is amazingly low. Don't delay—order one today. Shp. Wt. 8 lbs.

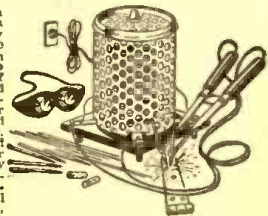

ITEM NO. 50
YOUR PRICE \$6.95

ELECTRIC HUMIDIFIER FOUNTAIN

Add healthful moisture to the air in winter. Evaporates as much as a pint of water in 24 hours. Fountain is 14" in diam. Sprays 8 streams of water 5" above fountain head. Made of spun aluminum. Comes in five colors: Bronze, chrome, copper, red, green. No water connections required. Just plug into 110 volt, 60 cycle A.C. outlet. Current consumption few cents a month. Complete with base switch and 8 ft. power cord. Shipping wt. 9 lbs. List price \$14.95. Only a limited supply on hand.
ITEM NO. 125
YOUR PRICE \$4.95



WESTINGHOUSE WATTHOUR METER

Completely overhauled and ready for immediate service. Designed for regular 110-volt, 60 cycle A.C. circuit. Servicemen use it in their shops to check current consumption of sets, soldering irons, etc. Keeps costs down. If dismantled, the parts alone would bring the price. The elaborate gear train could be used as a counter on machines of various kinds. Simple to install: 2 wires from the line and 2 wires to the load. Sturdily constructed in heavy metal case. Size: 8 1/2" high, 6 1/4" wide, 5" deep, overall. Shp. Wt. 14 lbs.
ITEM NO. 33
YOUR PRICE \$4.50



100 POWER TELESCOPE LENS KIT

Make your own high powered 8 ft. telescope. Now you can thrill to a close-up view of the worlds out in space. See the rings around Saturn, the mountains of the moon! Kit contains 3" diam., 75" focal length, ground and polished objective lens and 2 astronomical eye-pieces, magnification 50x and 100x. Complete kit with full instructions.
ITEM NO. 123
YOUR PRICE \$1.95

NEW—EXTRA LARGE LENS KIT—contains completely finished 4" diameter 100" focal length ground and polished objective lens, three 1 1/4" diameter eye-pieces giving 66x, 133x, and 200x, an aluminized diagonal for overhead viewing, and a color filter for insertion in any eyepiece.
ITEM NO. 123L
YOUR PRICE \$3.95



1941 Catalog

A POSTAL CARD BRINGS IT TO YOU

SEND FOR IT TODAY

HUDSON SPECIALTIES CO., 40 West Broadway, N. Y. C.

IT'S EASY TO ORDER—CLIP COUPON—MAIL NOW ORDER FROM THIS PAGE.

HUDSON SPECIALTIES CO., 40 West Broadway, Dept. RT-941, New York, N. Y.

I have circled below the numbers of the items I'm ordering. My full remittance of \$..... (include shipping charges) is enclosed.

OR my deposit of \$..... is enclosed (20% required), ship order C.O.D. for balance. No C.O.D. order for less than \$2.00. (New U. S. stamps, check or money order accepted.)

Circle Item No. wanted: 11, 33, 50, 87, 123, 123L, 125, 147

Name Address

City State

Send remittance by check, stamps or money order; register letter if you send cash or stamps.

RECENT RADIO AND TELEVISION PATENTS

DIPOLE ANTENNA

2,240,298 issued to Harold J. Heindel, Flushing; Milton B. Sleeper, New York, and Madison Cawein, Manhasset, N. Y.

● THE present invention concerns electromagnetic wave antennas and in particular a novel form of dipole antenna useful at ultra high frequencies.

One object of the present invention is to provide an improved dipole antenna.

Another object is to provide an antenna having improved electrical characteristics and at the same time improved mechanical characteristics.

A further object is to provide a novel dipole antenna adapted to simple adjustment for optimum directional and frequency response characteristics.

A feature of this invention is to provide a novel lightning arrester in conjunction with the impedance matching means of a dipole antenna.

A dipole antenna of the type utilized in the present invention comprises two equal, oppositely directed, horizontal antenna elements. The two antenna elements are mounted coaxially and spaced apart by a small distance. Lead-in wires are connected to the inner ends of the two elements.

The present antenna embodies a number of novel features. The two antenna elements are mounted on a central weather-proof housing containing preadjusted impedance matching elements, the connections to the lead-in wires and a lightning arrester. The housing is mounted on a coupling block adapted to fit over the end of an antenna pole. The two antenna elements are further supported by means of stream-lined arms mounted in the coupling block and supporting the antenna near its outer ends. A coupling section is provided in the pole allowing the antenna to be rotated to an optimum receiving angle after which it may be permanently fastened in position. The

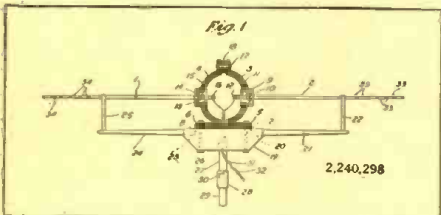

outer ends of the antenna elements are scored at points at which they may be cut-off to provide shifting of the optimum or average frequency response point of the antenna. We prefer to call our novel antenna a teleceptor.

AUDIO-FREQUENCY AMPLIFIER

2,245,365—issued to James M. Riddle, Jr., West Collingswood, N. J.

● ONE object of the present invention is to provide an improved audio frequency amplifier of the inverse feedback type having a frequency-responsive network and means for including said network selectively either in the internal circuit of the feedback loop or main signal channel, or in the

external circuit of the feedback loop to provide selective accentuation or attenuation of signals in a relatively narrow band or at a critical frequency.

The invention is particularly adapted for use in aircraft receivers operating in connection with radio beams for accentuating the range tone of the beam or suppressing the range tone when utilizing the beam for telephone conversation. The range tone frequency is included in the audio frequency band and usually falls at approximately 1,000 cycles. Hence, it may be heard along with the voice modulation from a transmitter carrying both voice and range tone modulations. During flying time, ordinarily it is desirable to accentuate the range tone, particularly during periods of adverse atmospheric conditions affecting radio reception, while, for periods during which communication is necessary by voice, it is desirable to suppress the range tone.

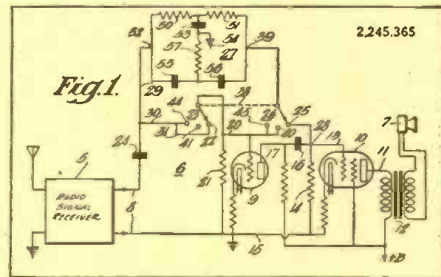

SUPER-REGEN. AMPLIFIER

2,244,261—issued to Karl Rath, New York, N. Y.

● IN this application there is described a regenerative system wherein amplified output energy is applied or fed back upon an input circuit purely electronically by the provision of a pair of electron discharge paths arranged in parallel relationship and connected with the input and feedback circuit, respectively. An advantage of such an arrangement is the fact that both the main amplifier currents and the feedback currents may be adjusted as to amplitude, frequency, phase, etc., in a most accurate manner substantially independent of each other. This enables any desired modification of the main amplifier current by regenerative or degenerative feedback and improves the efficiency and stability of regeneration.

An object of the present invention is to employ this principle in a super-regenerative amplifier wherein the regenerative action is controlled or stabilized by means of an interrupting or quenching signal applied to the main amplifier circuit through pure electron coupling.

Another purpose is to provide a highly stabilized and efficient super-regenerative amplifier which can be adjusted easily to suit any special requirements as to degree of regeneration, permissible distortion and other operating conditions.

A further object is the provision of a super-regenerative amplifier in which re-

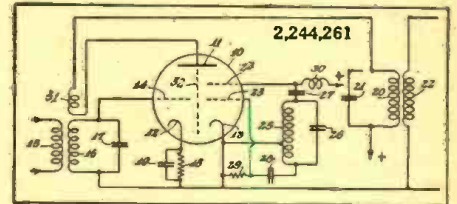

generative or feedback potentials are applied to react upon an input signal in such a manner that the degree of amplification and the quenching effect can be regulated entirely independent of each other.

A more specific object is to provide a super-regenerative amplifying circuit for radio frequency signals wherein the same tube not only serves as a regenerative amplifier, but also to impose a periodic quenching effect upon the amplifier or load circuit to render the resultant effective resistance in the latter periodically negative and positive at a rate above the highest modulating frequency of the signals being amplified.

AUTOMATIC DIVERSITY SWITCH

2,243,118—issued to Harold O. Peterson, Riverhead, N. Y.

● TO date, the use of diversity reception in amateur and home receivers has been very much limited by the added expense of providing two or more receivers for reception of a given signal. The invention relates to a diversity system in which only one receiver is required. A switching arrangement is provided whereby the input of the receiver can be connected to either one of two receivers.

An object, therefore, of the present invention is to provide means for automatically switching a receiver from an antenna in which the signal strength has fallen to a predetermined minimum to a second antenna receiving the same signal but in which the signal may be of greater amplitude.

An embodiment of my invention includes structure responsive to the developed automatic volume control voltage in a receiver for actuating either a mechanical relay or a pair of thermionic relays for switching the receiver from one antenna to another either at the same location but of different characteristics, or at a different geographical location. In a modified form of the invention the switching of antennas is responsive to a comparison between rectified carrier voltage and the rectified signal in said carrier.

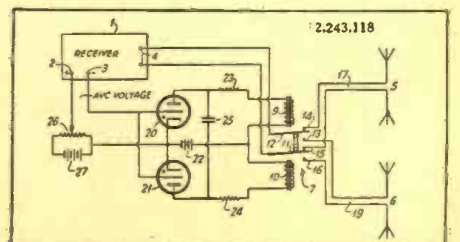

TELEVISION CONTROL DEVICE

2,244,251—issued to Alfred N. Goldsmith, New York, N. Y.

● THIS invention has for one of its purposes the means whereby different areas of the television studio set may be televised at will without actually moving the television camera.

the camera about a horizontal axis which may be simulated by moving a relatively light control member associated with the camera without actually moving the comparatively large and heavy camera itself.

Another purpose of the invention is that in addition to the controlling of the panning

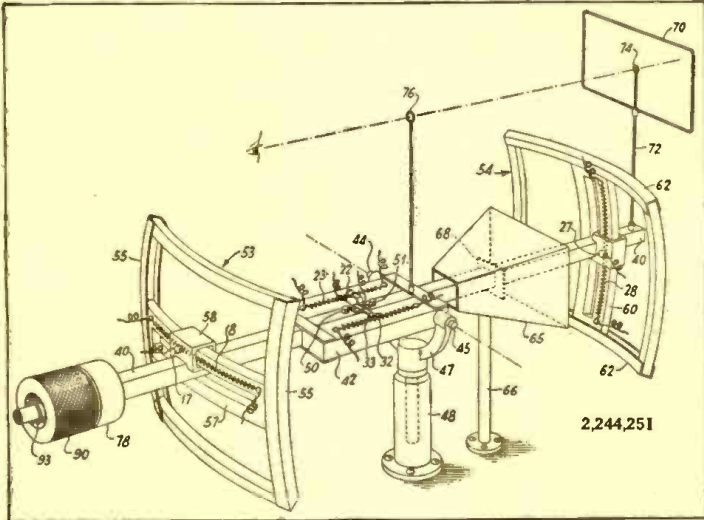

A further object of the invention is the provision whereby the effect of an approach of the television camera toward the subject to be televised, or a receding therefrom, may be simulated without actually moving the camera or without changing in any way the lenses associated with the camera.

Another purpose of this invention is the provision for the operation of moving the television camera in a horizontal plane about a vertical axis such as a panning operation may be brought about by purely electrical means without actually moving the camera per se.

This device provides the effect of tilting

action, the tilting action and the approach or receding action of the camera from a single control member, other means are provided whereby the intensity of the scanning cathode ray beam, focus or both may be controlled by still another manipulation (such as rotation) of the same control member.

The particular area is scanned, as well as the size of the area, which may be ascertained by a view-finder, so positioned that the operator of the camera may at all times know what portion of the television studio set is being scanned and transmitted at the particular instance.

FIXED PLATE CONDENSER

2,243,829—issued to George F. Brett, Chelmsford, and Nyman Levin, Finchley, London, England.

● ACCORDING to this invention a variable condenser comprises at least two spaced condenser electrodes, a means for generating and directing a concentrated beam of electrons between said electrodes, means for receiving said beam, means for varying intensity of said beam and connections connecting said electrodes as condenser electrodes in an external circuit, the whole arrangement being such that variation of said intensity produces a variation of the capacity between said electrodes.

The electron beam may be, for example, of flat ribbon form or of pencil form, and

the condenser electrodes may have any of a wide variety of forms, e.g., ordinary parallel flat plates may be employed.

The electron beam may be produced by any suitable form of electron gun, e.g., by a gun having a rectilinear cathode, a control electrode, and an accelerating anode situated outside the space between the condenser electrodes, a collector anode being also positioned outside said space and opposite said gun to receive said beam.

The intensity of the beam may be varied in any number of ways, e.g., by varying the potential of the control electrode, or by varying the heating of the cathode.

If desired an electronically variable condenser as above described may be used to compensate for variations due to warming up of valves in a radio transmitter or like system. In such a case the intensity of beam current in the condenser may be controlled by varying the temperature of the cathode thereof, which would be matched to the warming up time of the valves, the increase of beam current in the condenser gradually producing a decrease of capacity between the two condenser electrodes such as to compensate for increases in capacity of the valves.

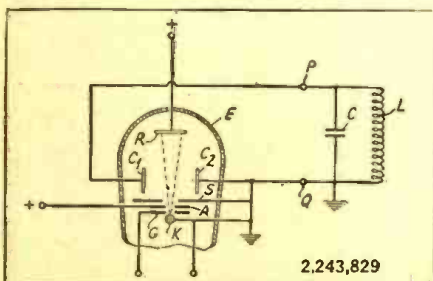

Astonish YOUR FRIENDS!

Pass 500,000 Vts. Thru the Body! Light Lamps, etc.

NEW! 5-ft. Spark Oudin Coil, Condenser & 4 k.w., 40 k.v. Transf. data. net 75c

DATAPRINTS

Drawings & Construction Data Show You How

20c Each in Order for 10

TESLA-LOUDIN HI-FREQ. COILS
(Data and Drawings only; no parts included)

36" Spk Tesla-Oudin Coil..... 40c
(1 K.W. Exc. Trf. Data, included FREE!)

8" Spk Tesla-Oudin Coil..... 40c
(1/2 K.W. Exc. Trf. Data included FREE!)

3" Spk Oudin; 110 Vt. "Kick Coil" type..... 40c

3" Spk Tesla Works on Ford Spk Coil..... 40c

1" Spk Violetta Hi-Freq. Coil..... 40c

FREE with order for \$1.00 or more—20 Tricks with Hi-Freq. Coils" (40c separate)

TELEGRAPHONE—Records on Steel Wire 40c

20 ELECTRIC PARTY AND LODGE TRICKS!
Loads of Fun!

How to Do 'em!..... 40c
New Electric Ore & Pipe Locator..... 40c

Solenoid & Magnet Data—Get Our List!

20 Telephone Hook-ups—Build Your Own . . 40c

RADIO CONTROL FOR MODEL BOATS, PLANES
Data 40c
Photophone; Data 40c

S-W DIATHERMY
(Artificial Fever)

Dataprint giving Constructional data for Small, Medium and Large size ADD. (All 3)..... 40c

"MIND READING" Radio Act 40c

"Fry Eggs" on cake of Ice! Data 40c

LOOK at these DATAPRINTS ! !

40c Each. See Special Prices below

20 A.C. Problems and their Solutions. Welding Trans. 2 K.W. Rewinding Armatures. Water Wheels

1/2 Meter Transm. & Rec. Meter Supernet. Water Turbines

100 Mechanical Movements. Wheatstone Bridge. Photo-tell and Relay Data

20 Motor Hook-ups. Electric "Inductor" Organ 20 Simple Bell Circuits.

Special Prices: 4 prints \$1.00; 10 for \$7.00; 40c each, single orders. Get New List 100A

The DATAPRINT Co.
Lock Box 322A RAMSEY, N. J.

PATENT YOUR IDEA

OTHER MEN have read and profited by our free books "Patent Protection" and "Selling an Invention". Fully explain many interesting points to inventors and illustrate important mechanical principles. With books we also send free "Evidence of Invention" form. Reasonable fees, deferred payments. forty-three years' experience. Write to: Victor J. Evans & Co., Registered Patent Attorneys, 905-K, Victor Building, Washington, D. C.

PATENTS—TRADE MARKS

Booklet concerning Inventions & Patents Form "Evidence of Conception" with instructions for use and "Schedule of Government and Attorneys Fees"—Free

LANCASTER, ALLWINE & ROMMEL
Registered Patent Attorneys
436 Bowen Bldg. Washington, D. C.

Inventions Wanted
Patented or Unpatented

We have been successfully selling inventions, patented and unpatented, since 1924. Write us, if you have a practical, useful idea for sale.

CHARTERED INSTITUTE of AMERICAN INVENTORS
Dept. 109 Barrister Building, Washington, D.C.

MAKE MORE MONEY! SPEED Up Your Work!

Learn to Type
without
A Typewriter



Master the Touch System — **Quickly** —
Accurately Get the "Feel" of Typing
Before Investing Your Money

Now, you don't have to own a typewriter to learn how to type. The ingenious, patented "Tuch-Rite" board gives you all the practice you need for speedy, accurate typing. It teaches you the touch system—the real, professional way universally used in business.

You may have been a "hunt-and-peck" typist for the longest time or you may never have used a typewriter before—it doesn't matter, because the "Tuch-Rite" teacher will soon permit you to master it.

"Tuch-Rite" is a scientific substitute for a typewriter. It is a life-size counterpart of a standard keyboard, which is real as to size, position, and "feel". Each key has a depression in the 1/4" thick board, in which the black plastic buttons slide. Printed under each key is a number which indicates the finger of each hand which strikes it—simple as A B C.

"Tuch-Rite" is highly recommended by the Office of Education, Federal Security Agency, Washington, D. C. An 8-page illustrated book of instructions will show you how best to use the "Tuch-Rite" teacher. Weight 3 lbs. Add postage **\$2.00**

GOLD SHIELD PRODUCTS

350 Greenwich Street Dept. RT-941 New York, N. Y.

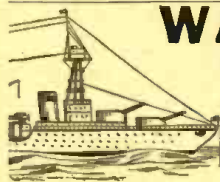

WARSHIP MODEL PRINTS

\$6-10,000 ton U.S. Navy 37' Cruiser, Model blueprints... \$3.15 (Complete Kit, all fittings... \$28.00; Hull Kit... \$7.75)

\$4-U.S. Destroyer: 39' exact model; Blueprints... \$1.60 (Hull constr. Kit \$5.60; complete Kit \$33.50)

\$2-"Constitution" (Old Ironsides) 25' Model, Blueprints... \$2.20 (Complete Kit \$35.00; Hull Kit \$6.50)

\$7-"Rob't. E. Lee"-Mississippi River Steamboat: 28' long, Blueprints... \$2.60 (Complete Kit \$22.00; Hull Kit \$6.50)

\$2-"Clermont"—first steamboat (blueprints)... \$1.10 (Complete Kit for 18" Model—\$7.00 Prepaid)

DATAPRINT CO.

Box 322, Ramsey, New Jersey

GREATEST SLIDE RULE VALUES EVER OFFERED



LAWRENCE 10-inch white enameled slide rule with clear glass magnifier in Black Case. Price includes 28-page instruction book, prepaid... **60c**
Secret Code slide rule, with 20-page book... **30c**
2 for 50c

8" Slide Rule... **25c**

Illustrated Book of Instructions... **10c**

Postage Prepaid
GOLD SHIELD PRODUCTS
Dept. RT-941 350 Greenwich St. New York

When subscribing to Radio & Television, you can have your choice of four different Radio books or a Modern Webster Dictionary, absolutely FREE of charge!

See advertisements on Pages 296, 303 and 316.

USED Correspondence Courses

COMPLETE HOME-STUDY COURSES and educational books, slightly used. Sold, rented, exchanged. All subjects. Money-back guarantee. Cash paid for used courses. Full details and illustrated 72-page bargain catalog FREE. Write today!

NELSON COMPANY, 500 Sherman, Dept. J-210, Chicago

Simple Test Circuit Lladd MacDonald

● BEING a newcomer in the servicing game, and not having too much money to lay out on test equipment, I built myself this little test circuit which I am enclosing. Mounted on a plywood panel it looks nearly as good as something a whole lot more expensive and works equally as well.

Numbers 1 and 2 on the schematic are test prod leads, and when panel mounted, I also installed tip jacks for phones as well as test prods. (See picture)

The speaker mounted on the panel, I use for aural check on coils, condensers, etc. I place a small battery across the speaker leads in this case. I also use the speaker (12" P.M. type) with test prods and alligator clips on any radio set I am servicing, if the speaker on said receiver is out of order or disconnected from set. (Disconnect battery from speaker when using it this way.)

The voltmeter speaks for itself, and I'll explain about the test circuit shortly. For convenience, I used tip jacks wherever possible. Fahnestock clips can be used just as well, or whatever happens to be handy in the junk box.

With this test circuit you can isolate the defective stage in an intermittent receiver. It can also be used for detecting a leaky coupling condenser, gassy tubes or distortion in the audio system. If necessary it can be used to align all types of sets, especially those using diode detectors and automatic frequency control circuits. Fig. 1 circuit will work as a rectifier, if the grid of the

30 tube is fed with a strong signal input. To do this simply advance the 3 meg. potentiometer.

For measuring changes in audio output, this will make the meter change with audio input voltage. A.C.-D.C. switch may be open or closed for this test, but on an aural test the circuit must not be noisy, so open the switch and rotate potentiometer until a clear medium signal is heard.

I hardly think it necessary to explain any further as to this little test circuit's many uses. Any one with a fair knowledge of radio principles will be able to locate and find the correct stage where distortion, etc., may be lurking.

This circuit is not at all new, and probably far from up to date. It does, however, serve the purpose very nicely when something more expensive cannot be had. Practically everything for this circuit can be found in the junk box. Any speaker can be used, and although I used cheap meters, more expensive ones will naturally work better.

The voltmeter, if connected to a battery, can also be used as an ohmmeter, if one is not available. Not the best testing equipment in the world, but for the beginner and experimenter, really cheap, practical equipment.

Anyone wishing complete testing details on this circuit may have them for a three cent stamp. Address the author in care of this publication.

Hook-up of Simple Tester here described.

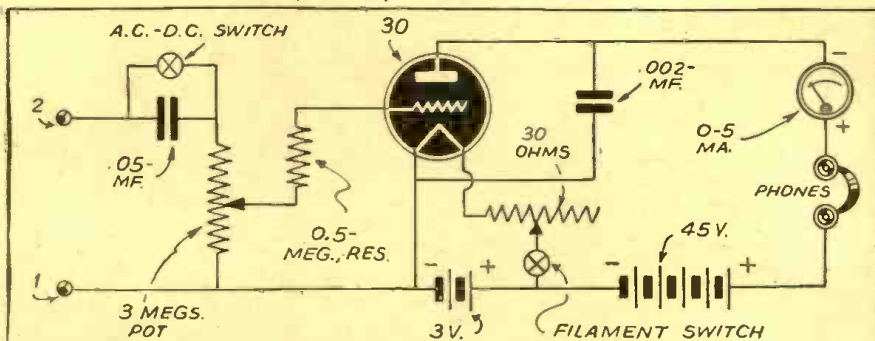

~ PARTS LIST ~

- 2- SWITCHES
- 1- .05-MF COND
- 1- .002-MF "
- 1- 3 MEG POT.
- 1- 30 OHM RES.
- 1- .5 MEG RES. (1/2-W.)
- 1- TYPE 30 TUBE
- 1- 0-5 MA METER
- 1- PHONE
- 1- SPEAKER
- 1- 3V. BATTERY
- 1- 45V. "
- 4- TIP JACKS
- 1- DIAL
- 1- 4 PRONG TUBE SOCKET
- PLYWOOD PANEL " 18" X 20"

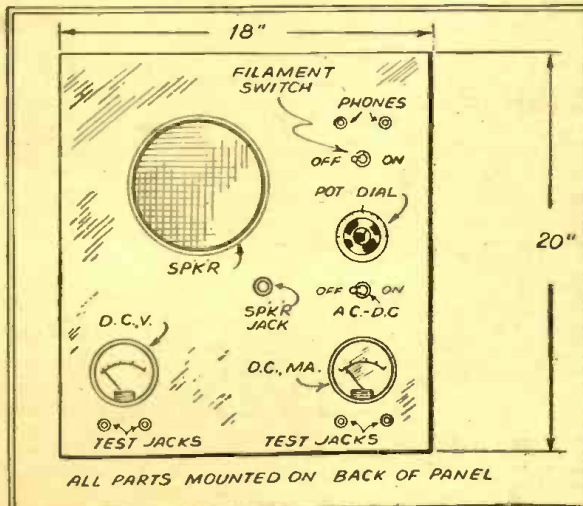

ALL PARTS MOUNTED ON BACK OF PANEL

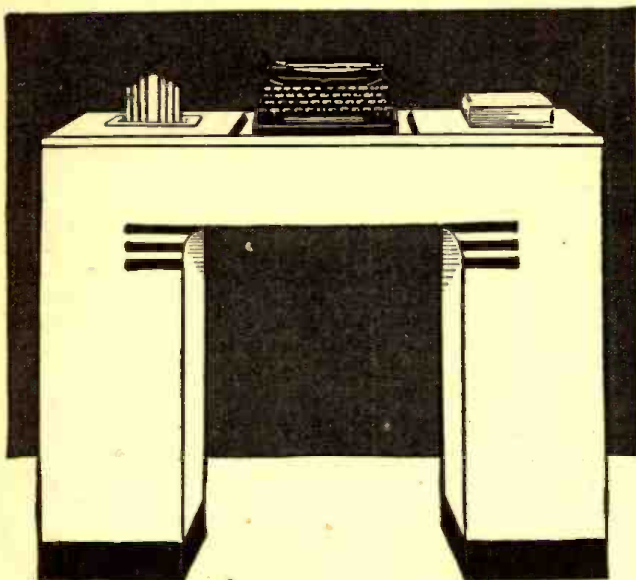

**THIS
BEAUTIFUL DESK
for only \$1.00 EXTRA**

**WITH ANY
REMINGTON
PORTABLE TYPEWRITER**

The
COMBINATION
FOR AS LITTLE AS
10¢ A DAY

How easy it is to pay for this combination of desk and Remington Deluxe Noiseless Portable Typewriter! Just imagine, a small good will deposit with terms as low as 10c a day to get this combination at once! You will never miss 10c a day. Yet this small sum can actually make you immediately the possessor of this amazing office at home combination. You assume no obligations by sending the coupon.

A beautiful desk in a neutral blue-green which will fit into the decorations of any home—trimmed in black and silver—and made of sturdy fibre board—is now available for only one dollar (\$1.00 extra) to purchasers of a Remington Noiseless Portable Typewriter. The desk is so light that it can be moved anywhere without trouble—it is so strong that it will hold six hundred (600) pounds. With this combination of desk and Noiseless Deluxe Portable Typewriter, you will have a miniature office at home. Learn the complete details of this offer. Mail the coupon today.

THESE TWO EXTRA FOR YOU

LEARN TYPING FREE

To help you even further, you get free with this special offer a 32-page booklet, prepared by experts, to teach you quickly how to typewrite by the touch method. When you buy a Noiseless you get this free Remington Rand gift that increases the pleasure of using your Remington Noiseless Deluxe Portable. Remember, the touch typing book is sent free while this offer holds.



SPECIAL CARRYING CASE

The Remington Deluxe Noiseless Portable is light in weight, easily carried about. With this offer Remington supplies a sturdy, beautiful carrying case which rivals in beauty and utility the most attractive luggage you can buy.



SPECIFICATIONS

ALL ESSENTIAL FEATURES of large standard office machines appear in the Noiseless Portable—standard 4-row keyboard; back spacer; margin stops and margin release; double shift key and shift lock; two color ribbon and automatic ribbon reverse; variable line spacer; paper fingers; makes as many as seven carbons; takes paper 9.5" wide; writes lines 8.2" wide. There are also extra features like the card writing attachment, black key cards and white letters, touch regulator, rubber cushioned feet. These make typing on a Remington Deluxe Noiseless Portable a distinct pleasure. Thousands of families now using the Remington Deluxe Noiseless Portable know from experience how wonderful it is!

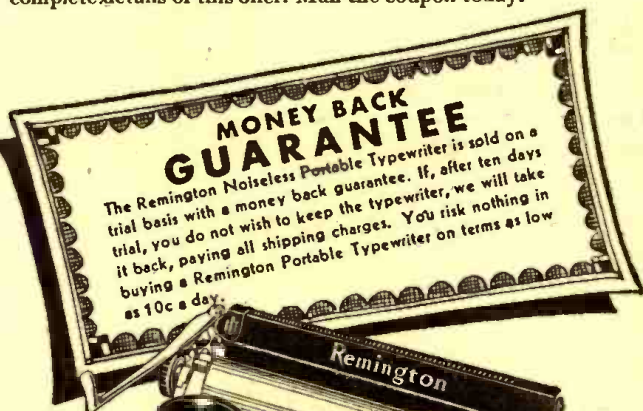

**MAIL
COUPON
NOW!**

Remington Rand Inc., Dept. 300-9
465 Washington St., Buffalo, N. Y.

Tell me, without obligation, how to get a Free Trial of a new Remington Deluxe Noiseless Portable, including Carrying Case and Free 32-page Typing Instruction Booklet on terms as low as 10c a day. Send Catalogue.

Name.....
Address.....
City..... State.....

New AC-DC Communications Receiver

Holmes Webster

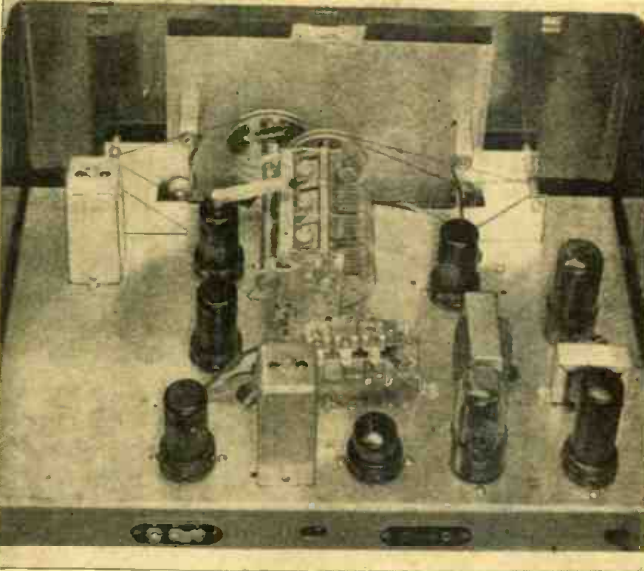

This new Junior Communications receiver has an amazing array of features. It has eight operating controls—tunes from 550 kc. to 30 mc. — band selector switch—band-spread — calibrated tuning dial, etc. Eight tubes are employed.

housed in an attractive metal cabinet and provided with eight operating controls to permit full control over all phases of its performance.

Front view of the new Echophone "Communications" receiver appears at left, also appearance of the rear of chassis.

Its tuning range is from 550 kilocycles to 30 megacycles and thus includes reception of every popular broadcast, commercial and amateur range, right down through the 10-meter ham band. This range is divided into three bands of 550 to 2100 kc. 2.1 to 8.1 mc., and 8 to 30 mc. which are selected by means of the 3-position "band-switch." Each band is fully calibrated in frequency on the upper half of the large tuning dial, and in addition to this the locations of the more popular *police, aviation, short-wave broadcast and amateur* bands are also indicated on the dial face.

● THE circuit of Figure 1 will be of interest to many hams and to both broadcast and short-wave DX'ers because of the unusual combination of features it offers. Constructors will find some worthwhile tips in the design and those whose interest is in operation rather than construction will find many features worthy of their consideration, particularly as this circuit is one which

is incorporated in a receiver selling in a price class way below that of the usual communications receiver and only a step or two above the ordinary home receiver of the compact type.

This receiver is the Echophone "Commercial", Model EC-2 which is shown in Figure 2 and in the layout view of Figure 3. It is a completely self-contained unit,

Diagram of the new 8-tube Echophone receiver.

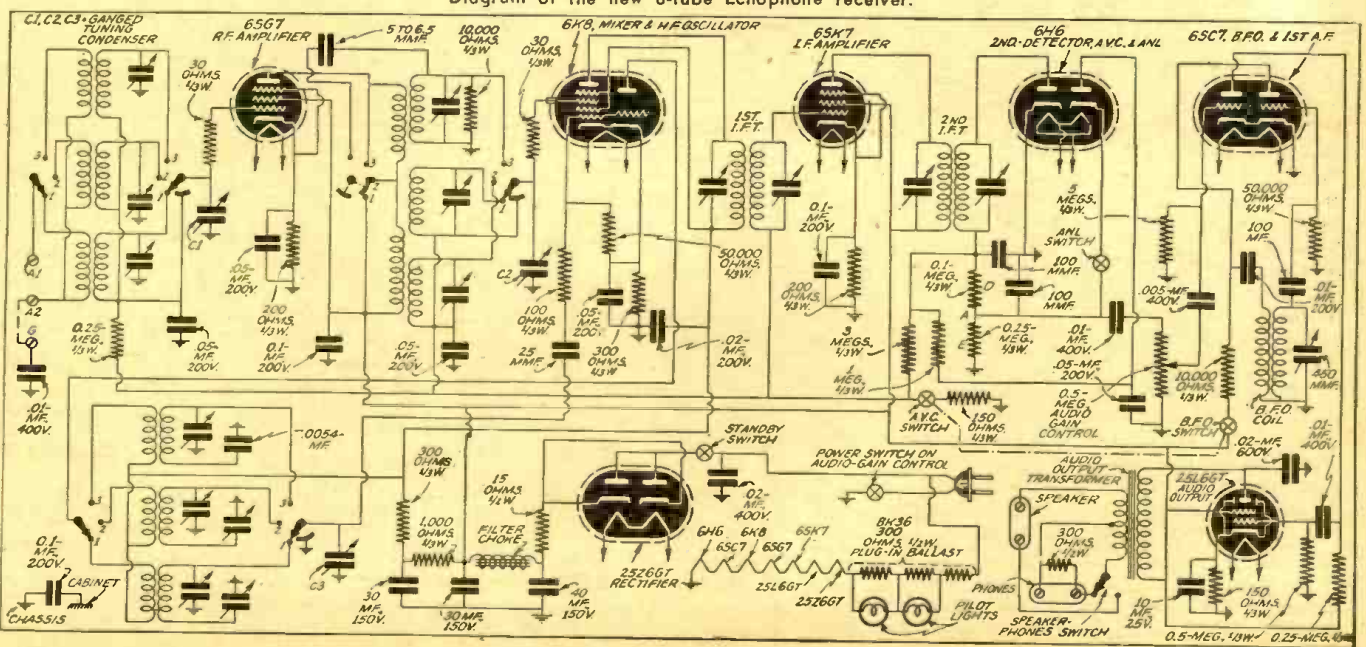

This tuning dial is really two-in-one, inasmuch as the lower half contains the separate *band-spread* tuning ranges. This is of the slide-rule type and is actuated by the separate band-spread tuning knob. It includes individual scales for the 80-, 40-, 20- and 10-meter amateur bands. In addition there is an 0-100 logging scale to permit the positions of other types of stations to be logged. Band-spreading is of the electrical type and is available for use in any part of the entire tuning range of the receiver. It is only necessary to set the main tuning dial at the high-frequency end of the smaller range which it is desired to cover. The effectiveness of the band-spread system is indicated in the fact that the 14-14.4 mc. range of the 20-meter amateur band is actually spread out over approximately 70% of the band-spread scale!

A listing of the other front-panel controls conveys some idea of the features offered by this receiver.

The two large upper knobs are the *main tuning* and *band-spread* tuning controls already discussed. Along the bottom edge, starting at the left, is the *Noise Limiter* switch which permits this feature to be taken advantage of when impulse noises such as automobile ignition, static, etc., prove troublesome. Next is the combination *audio volume control* and *power* switch. The *Beat-Frequency Oscillator* switch provides for cutting in this separate oscillator circuit for use in the reception of C.W. transmissions, or in locating weak phone signals. A *Speaker-Phone* switch offers the advantage that where headphones are to be used occasionally they can be plugged into the tip jacks provided at the rear of the receiver and left there permanently. Thereafter when it is desired to switch from speaker to phones or vice versa it is accomplished from the panel front by means of this throw-over switch.

Next in line comes the *band-switch* which permits instant selection of any of the three main tuning bands. Last is the *Standby* switch which, placed in the "off" position disconnects the plate-voltage supply to the entire receiver but leaves the filaments lighted for instant resumption of service when this switch is again placed in the "on" position.

The receiver operates from any A.C. or D.C. line rated at 115 volts and is therefore quite universal in its application. Those familiar with A.C./D.C. receivers will perhaps be surprised at the use of a metal cabinet to inclose this receiver. This is perfectly safe, however, and is made possible by the complete insulation of the cabinet from the "hot" chassis by live-rubber insulation. For home constructors who are interested in this it might be pointed out that the front and ends of this cabinet are a single piece, as shown in Figure 3, and it is on this piece that the chassis is floated on rubber. The top, bottom and back mount directly on this main assembly, entirely clear of the chassis except for the back which is of insulating material rather than metal and which allows access to the terminals on the rear of the chassis but avoids any possibility of shock. The mounting of the built-in loudspeaker is rather unorthodox, inasmuch as it is mounted in the cover of the cabinet facing upward. When the top is removed for purposes of servicing

or alignment, the speaker is disconnected by removing its plug from the receptacle at the rear of the chassis.

The other rear connections shown in Figure 3 are the headphone jacks already mentioned and the 3-way antenna connections which provide for use of any type of antenna.

Eight Tubes Employed

The receiver employs eight tubes in all, one of which is a ballast resistor (R22) to drop the line voltage to the value required by the series filament connections and to provide the shunt values required by the two dial lights.

Referring to the circuit diagram of Figure 1, it will be noted that the 6SG7 *preselector* stage is operative on all bands. This is considered highly important from the standpoint of operating effectiveness for not only does this tube and circuit provide increased sensitivity, but improves signal-to-noise ratio very appreciably and greatly reduces the two-spot tuning or repeat points which are so troublesome when tuning the short waves with a receiver that lacks this feature.

Following this is a 6K8 which serves as oscillator and mixer. These two tuned circuits and that of the preselector are, of course, ganged together for *single* control. The gang switch shorts out adjacent unused coils when set for either of the two high-frequency ranges. In addition it cuts in additional coupling between the preselector and mixer when in the 8-30 mc. position, by inserting the ceramic condenser C6 in this circuit. This helps to hold up the receiver's sensitivity at these high frequencies.

The 6SK7 I.F. stage is designed to provide high gain in combination with the highest practical selectivity to be afforded by four tuned circuits. It operates at 455 kc. The following 6H6 functions as detector, A.V.C. and noise limiter. About this latter function more will be said later. The 6SC7 double triode serves two independent purposes, one triode section functioning as an audio amplifier stage, the other as the *beat-frequency* oscillator. Enough coupling exists between leads to make other means unnecessary for coupling the B.F.O. output to the I.F. circuits. The switch SW4 in the plate supply lead to this section of the 6SC7 provides the means for cutting the B.F.O. in and out as needed.

The 25L6GT power tube provides one watt undistorted output for loudspeaker operation. When the *headphones* are switched in, however, the effective output is reduced as they are across only a part of the output winding. The resistor R23 serves as a constant load of suitable impedance to provide proper operating conditions for the tube, regardless of the type or impedance rating of the 'phones used. These can therefore be of either the ordinary or crystal types.

Noise-Limiter

The *noise-limiter* circuit employed is a highly effective one which has the advantage that it is entirely automatic in its action. It functions by effectively short-circuiting the audio output of the diode detector during individual noise impulses stronger than the signal. So rapid is its

action that, although the signal is eliminated as well as the noise during these brief intervals, the ear cannot detect the interruptions. The way it works is this.

The normal audio voltage is developed across the diode load resistor R16, with the left-hand section of the 6H6 functioning as the detector. Through the action of this diode the voltage at point (A) is negative in respect to ground and that at the top of R16 even more so. This means that the plate of the noise limiter section of the diode is normally more negative than its cathode by the amount of the voltage drop across R16 and therefore this diode is non-conductive.

When a sudden noise impulse of greater amplitude than a certain predetermined value occurs, it is immediately reflected in a higher negative voltage across the diode load. Due to the time lag of R17 (1 megohm) and condenser C19 this change is not immediately transferred to the diode plate. The result is that instantaneously point B becomes positive in respect to point C. The diode then becomes conductive, shorting point A to ground through C19. All this happens in a split second, after which the normal voltage relationship is again assumed until another noise impulse again initiates this cycle. This split second is long enough, however, to chop out the noise impulse which caused the action.

The value of R15 determines the noise threshold at which the system will become operative because it is this that determines the extent to which B is normally negative with respect to C and therefore the noise voltage that will be required to reverse this relationship. Too low a value for R15 will result in the limiter going into action on voice peaks while too high a value will result in limiter action only on extreme noise peaks.

To some readers this discussion of the noise limiter may seem superfluous. A prospective purchaser of a receiver, for instance, is less interested in the technical working of such a circuit than he is in its practical operating effectiveness. But to the set constructor the noise limiter is usually a perplexing problem and it is hoped that this explanation will make it less so, enabling him to incorporate similar circuits in existing receivers or in new ones which he may have in prospect.

September Contents for Radio-Craft

Set Conversion Simplified
Isolating the Defective Stage
Operating Notes by Bertram M. Freed
F.M. Service—Part I, Antenna Installation and Service
How to Build and Use a Practical Frequency Modulator
Construction Details of a Modern 10-Watt A.F. Amplifier
Construction of a Practical Car Television Receiver, Part I
Applications of an A.F. Test Oscillator
Two Speakers are Better Than One
Television Stations—A Listing
Britain's Aircraft Radio Locator
Emergency Repair of Test Instruments

19 New G.E. Radio Sets

● SUPPORTING its conviction that the small radio receiver, or "extra set", currently presents users with a most logical and enjoyable extension of radio service the General Electric Co. has announced 19 new receivers for 1942, of which 18 are table models and one a console. These, with one other table model, a table-type radio-phonograph combination, and ten battery-portables, announced earlier, make up the new G.E. "L" line to date. New frequency-modulation equipment is to be announced.

Heading the line of new receivers is the single console (model L-915), a chest-on-chest type nine-tube receiver. The cabinet, standing 40 inches high, has a slanting control panel, end panels, and pilasters of American walnut with a decora-

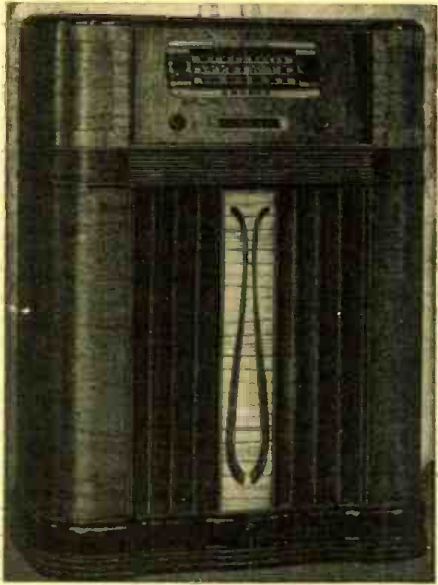

The Model L-915 9-Tube G.E. Receiver.

tive striped overlay. Vertical louvres characterize the general speaker grille. The set has three bands (550-1700 kc. standard, 1.7-5.2 meg. police, 5.2-18 meg. international short-wave) and two built-in beamscope antennas, eliminating the need for outside aerial or ground connections. One of the beamscopes is especially designed for short-wave reception.

A frequency-modulation or phonograph key serves to protect the owner's investment and makes it possible for him to utilize the set for frequency-modulation reception by means of an FM translator. A plug-in connection jack on the back of the chassis provides easy connection for translator or record player. Six feathertouch electric tuning keys, a 14-inch dynamic speaker, an inclined Visualux dial calibrated horizontally with the names of foreign cities clearly indicated, a continuously variable tone selector, and automatic tone compensation are other readily appreciable consumer features.

Drift-proof station settings consist of iron cores moved in or out of inductance coils by means of screw threads, providing permanence of settings with freedom from creeping or drifting. An iron core IF transformer enables the receiver to discriminate against unwanted stations, and a broad-band radio-frequency stage reduces background noises and increases enjoyable listening levels. A tone monitor circuit greatly extends the reproduction range of both highs and lows. The set had 9 watts maximum power output from push-pull beam power system, with sufficient volume to fill an auditorium. It is Underwriters' approved.

Of the small sets, beginning at the least expensive extreme, the first group of four are 1942 versions of the G.E. plastic model which last year was awarded national design recognition. They consist of cases in mahogany and ivory plastic.

The six-tube table models begin with another group of four sets (models L-600, L-601, L-610, L-611), in walnut and ivory plastic, with and without Underwriters' approval as desired. They are likewise AC-DC receivers, but have built-in beamscope antennas, a 5-inch dynamic speaker, broad-band radio frequency stage, and iron-core IF transformers to increase their performance.

Up the scale slightly are two new designs, one in mahogany plastic (model L-621) and the other in ivory plastic (model L-624). Also AC-DC sets both bear Underwriters' approval and employ six tubes, including rectifier. The molded plastic cabinet has a fresh grille treatment, the horizontal louver grille being parted in the center. These are two-band receivers, offering international short-wave reception, and having two built-in beamscopes for long- and short-wave reception without outside antenna or ground connections. They incorporate a five-inch dynamic speaker; inclined, illuminated horizontal dial; broad-band RF

NEW RADIO APPARATUS OF INTEREST

stage; a two-position tone selector located behind the volume control knob; iron-core IF transformers, and band-change control.

The remaining new plastic set (model L-650) is an AC-DC superheterodyne receiver, employing six tubes including rectifier, and having five electric tuning keys located below the dial scale.

The first of the wood-cabinet receivers (model L-613) is an AC-DC superheterodyne. It is a two-band model and has two built-in beamscopes, 5-inch dynamic speaker, broad-band RF stage, tone selector, iron-core IF transformer, and six tubes.

Two other AC-DC superheterodyne sets in the new line have substantially identical specifications with the set just described, except for styling and dial treatment. Each set has a new type curved and illuminated dial; and each offers standard broadcast and short-wave reception.

The final AC-DC table set (model L-652) is simple and modernistic in its lines. For standard broadcasts only, it has the speaker grille on top and offers the convenience of five electric tuning keys. It has a built-in beamscope, drift-proof settings, large illuminated dial panel in four colors, broad-band RF stage, tone selector, and six tubes.

Three straight alternating-current models complete the small set line.

Sun Radio Expands P.A. Department

● THE Sun Radio Co., of New York City, announces the expansion of their public address department with the leasing of the entire second floor, adjacent to their present building.

Henceforth to be known as "Sun Sound Studios", the new quarters will be devoted to the display and demonstration of home fidelity equipment as well as all classes of amplifiers and complete sound systems with their associated accessories, such as tuners, recorders, record players, automatic record changers, F.M. adaptors, speakers, pick-ups, microphones, etc.

A special sound-proofed interior, decorated in the modern manner to simulate actual home operating conditions, permits visitors and purchasers to make selection of suitable equipment.

Recording Discs

● THE Allied Radio Corporation, Chicago, announces the addition of an entirely new product, the low-cost Knight 6 1/2" double-faced Recording Discs.

Among the many features claimed are low-surface noise and excellent reproduction of high- and low-frequency response to aid in producing uniform recordings.

These double-faced Recording Discs are non-inflammable, slow-burning, and Underwriters' Approved. They are constructed with a durable cardboard base and coated on both sides to mirror-smoothness with a high-grade Type C Black Coating. Each flexible disc contains a label for type of recording, date, etc.

Currently available in quantities of 6 in 6 1/2" diameter size—8" and 10" sizes are to follow shortly. They are packed within strong manilla envelopes. The envelopes contain adequate numbered spaces for titles of records for convenient filing.



Motorola Home Radios

● AMONG the new Motorola items is the Motorola Automatic Wireless Record Changer with an improved, smoother-working, patented record changer. Another new item in the line to be featured will be a combination radio and automatic phonograph in which the phonograph is in a pull out "Roll-A-Way" Drawer. This drawer pulls in and out of the console chassis at the merest touch due to its "Feather Touch" Ball



Bearing Gliders. There is also the Self-Tuning Motorola, incorporating a most convenient feature. This set contains an electric clock mechanism, which pre-selects your programs at 15 minute intervals and tunes them in all day long, with no further attention on the listeners' part.

Westinghouse Receiver

● THIS new Westinghouse WR-290 receiver is an A.C. superheterodyne. It has three bands—standard, police and foreign short-wave; 6 stations can be selected by electrical pushbuttons. Electro-dynamic dustproof speaker is supplied; also phonograph jack. Power supply required is 105-125 v.—50-60 cycles A.C. Set has A.V.C. with 5 1/2 watts push-pull output; 16 to 1 vernier drive on tuning dial; 4 position tone control; inclosed loop antenna with terminals for auxiliary antenna; frequency range—540 to 1600 kc., 1600 to 4000 kc., 5800 to 18,000 kc.

A choice cabinet of walnut woods in the popular "waterfall" design. The dial is enhanced by green numerals and ivory calibrations. Dimensions: 17 1/4" wide, 12" high, 10 1/2" deep; net weight, 22 1/2 lbs.; shipping weight, 26 1/2 lbs.

Tubes: 6SK7, tuned R.F. amplifier; 6SA7, detector, oscillator; 6SK7, I.F. amplifier; 6SQ7, inverter; two 6K6GT, output amplifier; 5Y3G, rectifier.



One of the new Westinghouse Models—it covers short-wave and broadcast bands.

P.A. Amplifier

● WEBSTER-RAULAND announce their new 60 watt "Bi-Power" Amplifier. The unit has a newly designed circuit using to best advantage and in a most practical manner, the characteristics of a unique 5-tube power output, consisting of 3 rectifier tubes types 83 and 5U4, each performing a separate function in absolute relation to each other and obtaining maximum efficiency from two 6L6G tubes.

The unit, conservatively rated at 60 watts, incorporates such features as: 4 microphone inputs, 2 phono inputs with dual fader, complete mixing and fading on all 6 inputs, separate bass and treble tone controls, remote mixing of 3 microphones, illuminated panel, and many others.

Complete specifications and description of this new "Bi-Power" amplifier are found in the new Webster-Rauland catalog No. 141, available upon request from the Service Dept., RADIO & TELEVISION, 20 Vesey St., New York City.

New Hytron Tubes

• THE Hytronic Laboratories announce the addition of two instant-heating R.F. beam tetrodes to its line. One of these, the HY65, has about one-third the power capacity of the HY69. The HY67 has a 65-watt plate dissipation and more than twice the R.F. output of the HY69. Tentative characteristics for these tubes are as follows:

HY65
The HY65 is supplied with an all-ceramic octal base having 6V6GTX base wiring except for the plate which is connected to a top cap. The HY65 is completely shielded for R.F. and no neutralizing is required even at its maximum frequency rating of 60 megacycles.

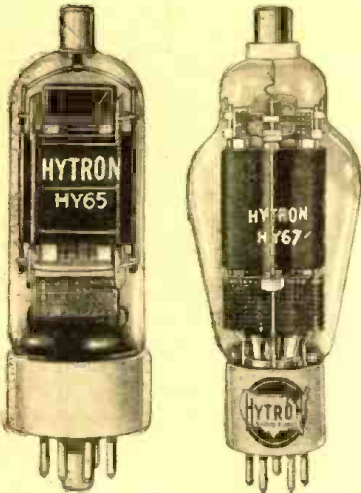

Two new Hytron tubes—the HY65 and HY67.

The HY65 is designed to replace the 6V6 and 6L6 type tubes in low-power stages and is for use also in portable and emergency type equipment. The instant-heating filament makes the HY65 particularly desirable for battery-operated transmitters where power must be conserved during stand-by periods.

All ratings given below are for continuous service operation.

Maximum Ratings and Typical Operation

Filament potential (A.C.-D.C.) instant-heating	5.7 to 6.6 volts
Filament current	0.8 A. at 6.0 volts
Average amplification factor	100
Mutual conductance	2300 micromhos
Input capacitance	9.5 mmf.
Output capacitance	7.4 mmf.
Grid to plate capacitance	0.12 mmf.

Plate and Screen Modulated R.F. Power Amplifier
(Carrier conditions per tube for use with maximum modulation factor of 1.0).

Maximum Ratings

D.C. plate potential	350 max. volts
D.C. screen potential	250 max. volts
D.C. grid bias	-150 max. volts
D.C. plate current	63 max. ma.
D.C. grid current	6 max. ma.
D.C. plate input	22 max. watts
Screen input	1.5 max. watts
Plate dissipation*	6.6 max. watts

*Rises to 10.0 watts when 100% modulated by audio of sine wave form.

Typical Operating Conditions

D.C. plate potential	250	350	volts
D.C. screen potential	200	200	approx. volts
D.C. grid voltage	-40	-45	approx. volts
D.C. plate current	60	63	ma.
D.C. grid current	3	3	ma.
Driving power	0.5	0.5	approx. watts
Power output	10	14	approx. watts

R.F. Amplifier and Oscillator Class "C" Telegraphy

Maximum Ratings

D.C. plate potential	450 max. volts
D.C. screen potential	250 max. volts
D.C. grid bias	-150 max. volts
D.C. plate current	63 max. ma.
D.C. grid current	6 max. ma.
D.C. plate input	28 max. watts
D.C. screen input	2.5 max. watts
Plate dissipation	10 max. watts

Typical Operating Conditions

D.C. plate potential	250	350	450	volts
D.C. screen potential	200	200	200	approx. volts
D.C. grid bias	-40	-45	-45	volts
D.C. plate current	60	60	63	ma.
D.C. grid current	3	3	3	approx. ma.
Driving power	0.5	0.5	0.5	approx. watts
Power output	10	14	19	approx. watts

HY67
The HY67 is an all-purpose graphite-anode R.F. beam power tetrode with rugged four-way mechanical support making the tube unusually well-suited for use in aircraft and similar applications where the equipment is subjected to extreme vibrations and mechanical shock. The R.F. shielding of the HY67 is complete, and, therefore, neutralizing is not necessary. (Cont. on pg. 317)

Lowest Priced Publications for Experimenters

10 FOR 50c

Here is a large number of radio, short-wave, and mechanical "how-to-make-it" designs.

Each is a special publication originated by masters in their respective fields. For the low price of 50 CENTS, you buy TEN complete pamphlets with photographic reproductions, complete mechanical layout, and full description to make it possible for anyone to build the project in question.

PLEASE ORDER EACH PROJECT BY ITS PUBLICATION NUMBER, and use the special coupon below.

We accept money-orders, cash, checks or new U. S. stamps. (No foreign stamps.) If you send cash or stamps, register your letter.

Money refunded if you are not satisfied.

ANY TWENTY-FOUR PUBLICATIONS FOR ONE DOLLAR.

SHORT-WAVE RECEIVER PUBLICATIONS

- | | | |
|---|---|--|
| HOW TO MAKE THE "OSCILLODYNE" 1 TUBE WONDER SET..... No. 101 | HOW TO MAKE THE 1-TUBE-ALL-ELECTRIC OSCILLODYNE..... No. 106 | HOW TO BUILD THE "DUAL-WAVE" SHORT-WAVE BATTERY RECEIVER..... No. 112 |
| HOW TO MAKE THE "19" TWIN-PLEX (ONE TUBE PERFORMS AS TWO) RECEIVER..... No. 102 | HOW TO MAKE THE 2 TO 5 METER TWO-TUBE LOUDSPEAKER SET..... No. 107 | HOW TO BUILD THE I-TUBE "53" TWINPLEX RECEIVER..... No. 113 |
| HOW TO MAKE THE WIZARD I-TUBE 50-WATT TRANSMITTER..... No. 103 | HOW TO MAKE THE 3-TUBE BATTERY SHORT-WAVE RECEIVER..... No. 108 | HOW TO BUILD THE PORTABLE MINIDYNE SHORT-WAVE BATTERY SET..... No. 114 |
| HOW TO MAKE THE IMPROVED 3-TUBE DOERLE SET FOR BATTERY OPERATION..... No. 104 | THE BRF-CASE SHORT-WAVE RECEIVER AND HOW TO BUILD IT..... No. 109 | HOW TO BUILD THE HAM-BAND "PEE-WEE" 2-TUBER..... No. 115 |
| HOW TO MAKE THE "GO-GET-EM 2" RECEIVER FOR THE BEGINNER..... No. 105 | HOW TO BUILD THE POCKET SHORT-WAVE RECEIVER..... No. 110 | HOW TO BUILD THE DUO-AMPLIDYNE..... No. 116 |
| | HOW TO BUILD THE CIGAR-BOX I-TUBE "CATCH ALL" RECEIVER..... No. 111 | HOW TO BUILD THE "MONOCOIL 2"..... No. 117 |

RADIO BROADCAST RECEIVER AND SPECIAL RADIO PUBLICATIONS

- | | | |
|--|--|---|
| HOW TO MAKE THE A.C.-D.C. "CASH BOX" RECEIVER..... No. 118 | HOW TO BUILD THE 2-TUBE "PENTODE PORTABLE" BROADCAST SET..... No. 122 | HOW TO BUILD A 6-TUBE BATTERY ALL-WAVE "FARM PORTABLE" SET..... No. 126 |
| HOW TO MAKE BEGINNER'S 2-TUBE ALL-WAVE SET..... No. 119 | HOW TO BUILD THE RADIO "TREASURE" FINDER..... No. 123 | HOW TO MAKE AN A.C.-D.C. ONE-TUBE "DEAF AID"..... No. 127 |
| HOW TO BUILD THE "RADIO-LAMP" 4-TUBE TABLE RECEIVER..... No. 120 | HOW TO BUILD THE GERNSBACK ONE-TUBE PENTODE LOUDSPEAKER SET..... No. 124 | HOW TO BUILD A PIANOTRON..... No. 128 |
| HOW TO BUILD A SUPER-SENSITIVE ALL-WAVE CRYSTAL SET..... No. 121 | HOW TO BUILD THE WORLD'S SMALLEST ONE TUBE BATTERY RADIO..... No. 125 | HOW TO BUILD THE ONE-DOLLAR RADIO..... No. 129 |
| | | HOW TO MAKE A VARIABLE-TONE CODE PRACTICE SET..... No. 130 |

MECHANICAL PROJECTS PUBLICATIONS

- | | | |
|---|---|--|
| HOW TO MAKE A SOUTH SEA OUTRIGGER CANOE..... No. 131 | HOW TO BUILD A SIMPLE PORTABLE REFRIGERATOR..... No. 138 | HOW TO MAKE YOUR OWN MICROSCOPE..... No. 144 |
| HOW TO BUILD A PEE-WEE AUTOMOBILE..... No. 132 | HOW TO BUILD A XYLOPHONE..... No. 139 | HOW TO MAKE A WIMSHURST ELECTROSTATIC MACHINE..... No. 145 |
| HOW TO BUILD A DUAL-CONTROL GLIDER..... No. 133 | HOW TO BUILD THE ROWMOBILE..... No. 140 | HOW TO MAKE A POWER DRILL PRESS FROM SCRAP PARTS..... No. 146 |
| HOW TO BUILD A HOUSEBOAT ON PONTOONS..... No. 134 | HOW TO BUILD LARGE TESLA AND OUDIN COILS GIVING 18-INCH SPARKS..... No. 141 | HOW TO BUILD A GOOD LATHE FOR \$1.00..... No. 147 |
| HOW TO MAKE A BAND SAW FROM OLD AUTO PARTS..... No. 135 | HOW TO MAKE AN ARC WELDER..... No. 142 | HOW TO MAKE AND EXPERIMENT WITH AN ELECTROPHOROUS..... No. 148 |
| HOW TO BUILD A REAL LATHE FOR \$5.00..... No. 136 | HOW TO USE AN A.C. ARC WELDER..... No. 143 | HOW TO MAKE AN ELECTRIC ARC WELDER FROM AN AUTOMOBILE GENERATOR..... No. 149 |
| HOW TO BUILD A SAIL CAT-BOAT..... No. 137 | | |

RADIO PUBLICATIONS • 20 Vesey Street • New York, N.Y.

RADIO PUBLICATIONS, 20 Vesey Street, New York, N.Y.

R&T-9-41

I enclose \$..... for the publications listed by number, at right, at the rate of 50c FOR ANY TEN PUBLICATIONS. NO ORDER FOR LESS THAN 50c ACCEPTED. \$1.00 for 24 publications. These publications are to be sent to me postpaid. I have placed a circle around each number which I want.

101	102	103	104	105	106
107	108	109	110	111	112
113	114	115	116	117	118
119	120	121	122	123	124
125	126	127	128	129	130
131	132	133	134	135	136
137	138	139	140	141	142
143	144	145	146	147	148
					149

Name Address

City State

SIX COPIES FOR 50c

For a limited time only, and as long as they last, we will send you six back numbers of RADIO & TELEVISION assorted, your choice, for 50 cents.

The usual price for six copies would be \$1.50, and most publishers charge a higher price for back numbers over one year old.

We can supply only the following back numbers: Sept., 1931; Sept., 1934; Aug., Oct., 1935; 1936—all issues except Apr., May and Oct.; 1937—all issues except Feb. and Aug.; 1938—all issues except March and Nov.; 1939—all issues except Jan., March and April;

1940—all issues except Jan. and April; 1941—all issues to date.

If you do not specify copies, we will send assorted numbers to fill your order. Note, we cannot exchange the copies for ones that have been sent to you.

Every copy of RADIO & TELEVISION contains information which you should have. Here is a chance to get those copies.

As only a small supply of back numbers is on hand, this offer will be withdrawn as soon as they have been sold.

We accept U. S. stamps, U. S. coin, or money order. Rush your order today.

RADIO & TELEVISION 9-41
20 Vesey Street, New York, N. Y.

Gentlemen: I enclose herewith 50c (Foreign: Add 25c for postage), for which you are to send me six back numbers of RADIO & TELEVISION as follows:

Name
Address
City State

THE FINEST RADIO BOOK

FREE

WE EVER OFFERED—
 the 1940-41 Radio-Television Reference Annual
With \$1.00 subscription to
RADIO & TELEVISION

WITH our compliments, we want to send a copy of the 1940 RADIO-TELEVISION REFERENCE ANNUAL to you FREE, if you will simply take advantage of RADIO & TELEVISION magazine's special subscription offer NOW. This offer is being made for a limited time only.

The 1940 RADIO-TELEVISION REFERENCE ANNUAL has 68 pages, large size 8½ x 11½, with over 170 illustrations. The contents of this book has never appeared before in handy book form. Its pages cover practically every branch of radio sound, public address, servicing, television, construction articles for advanced radio men and technicians, time and money-saving kinks, wrinkles, useful circuit information, "ham" transmitters and receivers, and a host of other data.

The Annuals have always been regarded as a standard reference work for every practical branch of radio operation and service. This 1940 edition ably sustains this reputation. Every radio man wants a copy of this valuable book. Just as this book will be of unquestionable value to you, so, too, will every monthly issue of RADIO & TELEVISION. This magazine brings you big value every month. It keeps you intelligently informed about new developments in radio and television. You want the news, want it fully but concisely, want it first—that is why you should read RADIO & TELEVISION regularly.

This very special offer is made for just one purpose—we want you as a regular subscriber. The Annual, whose contents appears at the right, is not sold, but a copy is FREE to you if you subscribe now.

**SAME SIZE AS
 RADIO & TELEVISION**

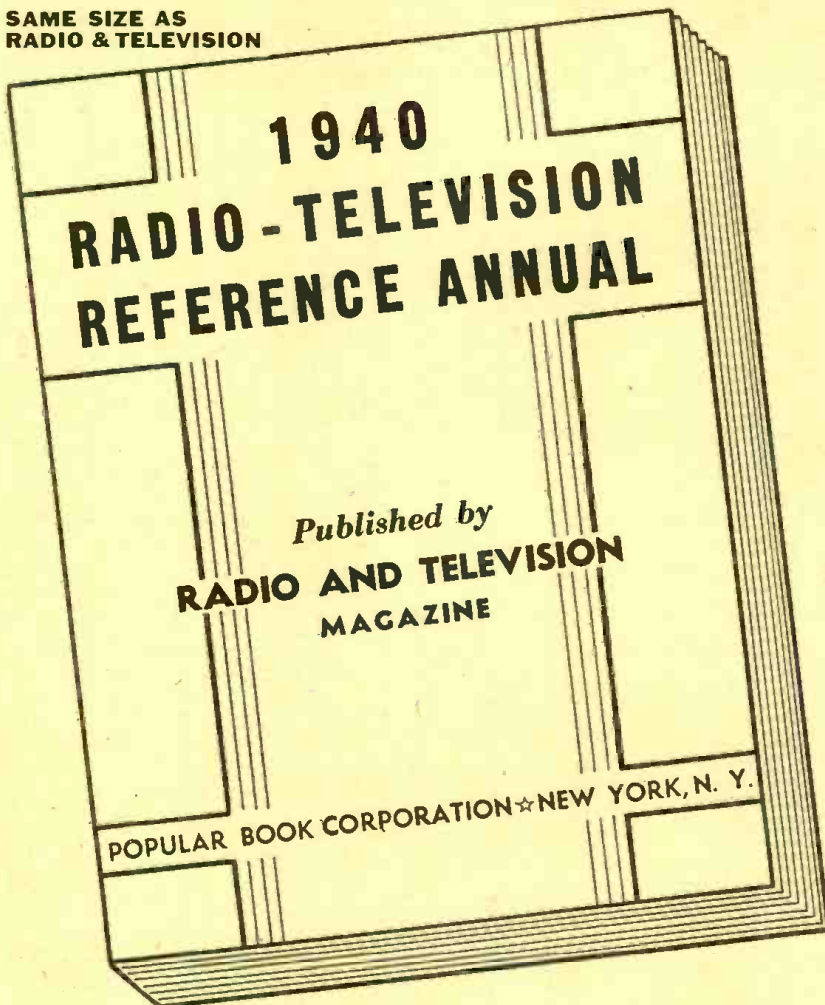

THIS COUPON BRINGS YOU THE ANNUAL

RADIO & TELEVISION • 20 VESEY STREET • NEW YORK, N. Y.

Gentlemen: Enclosed you will find One Dollar for which enter my subscription to RADIO & TELEVISION Magazine for Eight Months. Send me ABSOLUTELY FREE and POSTPAID, my copy of 1940 RADIO-TELEVISION REFERENCE ANNUAL. Canadian and Foreign Postage 30c extra.

This is a new order Extend My Present Subscription

NAME ADDRESS

CITY STATE

DON'T DELAY — MAIL TODAY! RT-9-41

**Read the summary of contents
 in this FREE BOOK!**

THE 1940 RADIO-TELEVISION REFERENCE ANNUAL contains a collection of the best and most important articles. Covering as they do nearly every branch of radio, they form a handy reference works. In addition, many time and labor-saving kinks, circuits and wrinkles, tried and tested by practicing Servicemen, experimenters and radio fans have been included. This book cannot be bought anywhere at any price. Yet it is yours by merely subscribing. Use the convenient coupon below.

**BEGINNER'S SIMPLE INEXPENSIVE
 CONSTRUCTION ARTICLES**

Beginner's Breadboard Special - a 1-Tube High-Gain All-Wave Receiver—Wiring Pointers for Radio Beginners—A Watch Charm Size 1-Tube Set—Beginner's Simple Volt-Milliammeter—Making a 1-Tube Broadcast Loop Receiver—A.C.-D.C. Power Supply for Battery Portables—A 1-Tube Short-Waver with Band Coll Switching.

MORE ADVANCED SET CONSTRUCTION

The "High-Seas 4" Broadcast Lamp Radio—How to Build a 6-Tube 1.4-Volt Short-Wave Superhet for the "Ham" or Short-Wave Fan—Build the "Lunch Box 5" Super Set—a Broadcast Battery Portable—How to Build a Plug-Together 8 Tube Broadcast Set—The "5-In-4" All-Wave Radio for A.C. Operation—An Easily-Built 3-Tube Midset Broadcast Superheterodyne Receiver.

THE SERVICEMEN'S SECTION

Base Tone Control—Simplified Variable Selectivity—Practical Servicing Pointers—Servicing Universal A.C.-D.C. Receivers—Killing the "Intermittent" Bug—A Service Shop A.C. to D.C. Power Supply—Sideline Money for Servicemen—Adding A.V.C. to any Screen-Grid T.R.F. Receiver—Iron Particles in Speaker Air Gap.

TEST INSTRUMENTS

A Useful Neon Lamp Tester—An Inexpensive Output Meter—Making Milliammeter Multipliers—Home-Made Frequency Modulator—The Busy Servicemen's V.T. Volt-Meter.

PUBLIC ADDRESS AND AMPLIFIERS

Build this Combination A.C.-D.C. Radio and Inter-Communicator—Speaker Placement in P.A. Work—The Design and Construction of an Inexpensive All-Push-Pull 10-Watt Amplifier—Obscure Sources of Hum in High-Gain Amplifiers—How to Build a High-Fidelity 5-Watt Versatile Amplifier.

"HAM" SECTION

Ultra-High Frequency Antennas—The Beginner's Low-Cost Xmitter-Modulator Meter—Phone Monitor—The Beginner's "Ham" Receiver—2½ Meter Acorn Transceiver.

TELEVISION

How to Build a 441 Line T.R.F. Television Receiver—Useful Notes on Television Antennas.

MISCELLANEOUS

Simple Photo-Cell Relay Set Up—Making a Burglar Alarm—How to Build A.C.-D.C. Capacity Relay—How to Make a Modern Radio Treasure Locator.

USEFUL KINKS, CIRCUITS AND WRINKLES

Making a Flexible Coupler—Two-Timing Chime—A Simple Portable Aerial—An Improved Non-Slip Screw-Driver. NOTE: The book contains numerous other useful Kinks, Circuits and Wrinkles, not listed here.

(approximately)

45 ARTICLES

(approximately)

170 ILLUSTRATIONS

68 BIG PAGES

**RADIO & TELEVISION
 20 VESEY STREET
 NEW YORK, N. Y.**

Maximum Ratings and Typical Operation
Filament potential (A.C.-D.C.)
instant-heating 5.7 to 6.6
or 11.4 to 13.2 volts

Plate and Screen Modulated R.F. Power Amplifier

Maximum Ratings		
D.C. plate potential	1000	max. volts
D.C. screen potential	300	max. volts
D.C. grid bias	-300	max. volts
D.C. plate	150	max. ma.
D.C. grid current	15	max. ma.
D.C. plate input	145	max. watts
D.C. screen input	7.5	max. watts
D.C. plate dissipation**	44	max. watts

**Rises to 65 watts when 100% modulated by audio of sine wave form.

Typical Operating Conditions		
D.C. plate potential	750	1000 volts
D.C. screen potential	300	300 approx. volts
D.C. grid bias	-150	-150 approx. volts
D.C. plate current	120	145 ma.
D.C. grid current	12	14 ma.
Driving power	2	2 approx. watts
Power output	64	101 approx. watts

R.F. Power Amplifier and Oscillator—Class "C" Telegraphy		
Maximum Ratings		
D.C. plate potential	1250	max. volts
D.C. screen potential	300	max. volts
D.C. grid bias	-300	max. volts
D.C. plate current	175	max. ma.
D.C. plate input	215	max. watts
D.C. screen input	10	max. watts
Plate dissipation	65	max. watts

Typical Operating Conditions		
D.C. plate potential	750	1000 1250 volts
D.C. screen potential	300	300 approx. volts
D.C. grid bias	-60	-70 -80 approx. volts
D.C. plate current	120	150 175 ma.
D.C. grid current	10	10 10 approx. ma.
Driving power	1.4	1.4 1.5 approx. watts
Power output	64	105 152 approx. watts

New RCA Tubes

● THE RCA Mfg. Co. has made available the following new tube types:

- RCA-6SL7-GT Twin-Triode Amplifier
- RCA-1631 Beam Power Amplifier
- RCA-1632 Beam Power Amplifier
- RCA-1633 Twin-Triode Amplifier
- RCA-1634 Twin-Triode Amplifier

The 6SL7-GT is a twin-triode amplifier of the high- μ (70), single-ended type with separate cathode terminals for each triode unit. It is recommended for use in resistance-coupled circuits as a voltage amplifier or phase inverter. This high- μ type, like the 12SL7-GT, has separate cathodes which are brought out to terminals in the base and, therefore, offers much greater flexibility from the circuit designer's standpoint than do other high- μ twin-triodes having only a single cathode connection.

The 1631, 1632, 1633, and 1634 are special-purpose tubes primarily for added convenience in the design of special storage-battery-operated mobile equipment. The 1631 and 1632 are intended for applications critical as to uniformity of characteristics, while the 1633 and 1634 are for applications critical as to matching of the two triode units. The 1631, 1632, and 1634 have 12.6-volt heaters and the 1633 has a 25-volt heater.

RCA-1631 BEAM POWER AMPLIFIER
For applications critical as to uniformity of characteristics

Heater Voltage (A.C. or D.C.)	12.6	Volts
Heater Current	0.45	Ampere
Plate Dissipation	16	max. Watts

Other ratings, characteristics, dimensions, and socket connections for the 1631 are the same as those for Type 6L6. Typical operating data for the 6L6 also apply to the 1631 within the limitation of the maximum plate-dissipation rating.

RCA-1632 BEAM POWER AMPLIFIER
For applications critical as to uniformity of characteristics

Heater Voltage (A.C. or D.C.)	12.6	Volts
Heater Current	0.6	Ampere
Plate Voltage	117	max. Volts
Screen Voltage	117	max. Volts
Plate Dissipation	5.5	max. Watts

Transconductance (at 110 volts plate & screen and -7.5 volts bias) 9000 Micromhos

Dimensions, and socket connections for the 1632 are the same as for Type 25L6.

Typical operating data for the 1632 are the same within plate voltage and dissipation limitations as for the 25L6.

RCA-1633 TWIN-TRIODE AMPLIFIER
For applications critical as to matching of the two triode units

Heater Voltage (A.C. or D.C.)	25	Volts
Heater Current	0.15	Ampere

Other characteristics, maximum ratings, dimensions, and connections for the 1633 are the same as those for Type 12SN7-GT.

COMMERCIAL NOTICES 10¢ A WORD

Under this heading only advertisements of a commercial nature are accepted. Remittance of 10¢ per word should accompany all orders. Copy should reach us not later than the 10th of the month for the second following month's issue.

INSTRUCTION
DRAFT HAS OPENED RADIO ANNOUNCING for you! Network announcer writes honest details. Getting and holding job. Mike technique. Transcriptions. Procedure. Everything! Twenty mimeographed pages of priceless instruction, \$1. Box 460, Elmira, N. Y.

\$15.00 STEAM ENGINEERING Course—8 vols., \$4.50; Radio and Electrical text-book bargains—Get list. Life of Napoleon, 3 do luxe volumes \$3.00.

\$10.00 New Cyclopaedia of Science, 1300 pp., \$4.50; Hopkins' "Experimental Science," 2 vols. \$3.50. Harry Ackerson, Box 322, Ramsey, N. J.

Products, Dept. 941, 350 Greenwich St., New York City.

PATENT ATTORNEYS

INVENTORS — PROTECT YOUR rights before disclosing your invention to anyone. Form "Evidence of Conception"; "Schedule of Government and Attorneys' Fees" and instructions sent free. Lancaster, Allwine & Rommel, 436 Bowen Building, Washington, D. C.

MOTORS

RECONDITIONED MOTORS, 1/50 HP, AC-DC, Nickel \$1.50; 1/30 HP, black \$2.50. Fully guaranteed. F.O.B. New York. Wonderful value limited quantity. Act Promptly! Gold Shield

FOR SALE (NON COMMERCIAL) 3¢ A WORD

Under this heading we accept advertisements only when goods are offered for sale without profit. Remittance of 3¢ per word should accompany all orders. Copy should reach us not later than the 10th of the month for the second following month's issue.

SELLING SMALL NEAT XMITTER, S20R, QST's, Richard Lplander, Hubbell, Mich.

Haltercrafters, Nationals, Hammands, RME, Howards, all other makes and models at lowest prices. Write for free list. W9ARA, Butler, Missouri.

guaranteed Receivers! Practically all models at money saving prices. Trade-ins. Time Payments. Send for list, W2AVA, 12 West Broadway, New York.

RECONDITIONED GUARANTEED communications receivers cheap. Free trial. Three months guarantee. Terms.

BARTER AND EXCHANGE — 1¢ A WORD

NO ADVERTISEMENT TO EXCEED 35 WORDS, INCLUDING NAME AND ADDRESS

Space in this department is intended solely for the benefit of our readers, who wish to BUY or EXCHANGE anything in the Radio, Television and Photographic fields for Radio, Photographic and other merchandise; therefore we charge only 1¢ a word. Each word in a name and address is counted. Remittance should accompany order.

We cannot accept responsibility for any statements made by the readers. All dealings MUST be above board. Remember you are using the U. S. mail in all these transactions and therefore you are bound by the U. S. Postal Laws. Describe anything you offer accurately and without exaggeration. Treat your fellow men the way you wish to be treated.

Only one advertisement can be accepted from any reader in any one issue.

We welcome suggestions that will help to make this department interesting and helpful to our readers.

Copy should reach us not later than the 10th of the month for the second following month's issue.

WANTED—BOUND VOLUMES OR individual copies of Modern Electrician, Electrician and Mechanic, Electrical Experimenter, and similar magazines published prior to 1920. Also want vacuum tubes of this vintage. Gerald Tynes, 191 Claremont Ave., New York City.

GENERAL ELECTRIC TWO HORSE two twenty direct current motor. Verde piano-accordion. Chevrolet car radio heater, electric clock. Clough-Brengle signal generator, other instruments from dismantled test bench. What's your trade offer? G. Watt, Chanute, Kans.

HAVE 1937 SKY BUDDY IN A-1 condition, also vertical antenna. Good receiving combination, ideal for beginner. L. B. Pruette, 1520 S. Tryon St., Charlotte, N. C.

HAVE ONE MODEL 800-A TUBE and set tester without meter. Also new model 50 carbon D.B. mike with stand and transformer. What have you to offer? Fred Vogel, Lakefield, Minnesota.

WANTED: U.H.F. EQUIPMENT preferably a transceiver. Will trade SW3 complete. Also have No. 6 chemistry set. What have you? Victor Felton, 1119 S. Mich. Ave., Wellston, Ohio.

FREE! CONDENSERS, RESISTORS, coils, transformers, tubes, radio magazines, etc. Have no use for these items and dislike throwing them away. Specify preferred parts. Include postage. Gerald Pirisk, Blue Earth, Minn.

WANTED: MAC OR BUD CODE Oscillator. Have xtal phone pickup and amplifier, radio mags, etc., to swap. George Cryder, Delaware, Ohio.

HAVE SUPERIOR TUBE-SET TESTER, Philco All-wave, Binoculars, Holstein, 246 E. 148th, Bronx, N. Y.

SWL EXCHANGE

This department is for the benefit of all short wave listeners who wish to exchange SWL cards. Remittance of 10¢ a word for each word in the name and address should accompany order.

WANTED: RIDER'S MANUALS 9-10-11, oscillograph, amateur receiver, home diathermy set, Gustave Mond, rush, 600 Beechmont, Dearborn, Mich.

WISH TO EXCHANGE IDEAS WITH electrical experimenters. Electric Shop, Logan, Kansas.

UNITED STATES
ALBERT L. MEIBURG, Clemson, S.C.

RCA-1634 TWIN-TRIODE AMPLIFIER
For applications critical as to matching of the two triode units

Maximum ratings, characteristics, dimensions, and socket connections for the 1634 are the same as for Type 12SC7.

6SL7-GT TWIN-TRIODE AMPLIFIER
(Tentative Data)

Ratings are to be interpreted according to RMA Standard M8-210 (Jan. 8, 1940 Rev. 11-40)

Heater Voltage (A.C. or D.C.)	6.3	Volts
Heater Current	0.3	Ampere
Maximum Overall Length	3-5/16"	
Maximum Seated Height	2 3/4"	
Maximum Diameter	1-5/16"	
Bulb	T-9	

Base—Intermediate Shell Octal 8-Pin
Mounting Position—Any

Amplifier—Each Unit

Plate Voltage	250	max. Volts
Grid Voltage	0	min. Volts
Plate Dissipation	1	max. Watt

Characteristics—Class A, Amplifier:

Plate Voltage	250	Volts
Grid Voltage	-2	Volts
Amplification Factor	70	
Plate Resistance	44000	Ohms
Transconductance	1600	Micromhos
Plate Current	2.3	Milliamperes

ratio-coupled oscillator, an untuned detector, and a rectifier-filter power supply. It is designed for accurate and economical monitoring of transmitters on any frequencies up to 56 megacycles. A calibration table shows the relation between fundamental frequency and dial reading. Measurements on local transmitters outside the fundamental range are readily made by means of harmonics, or their combinations, heard in the untuned detector. It is made by the Lampkin Laboratories.

For maximum convenience, charts are supplied reading directly in percentage deviation from assigned channels. On medium or on ultra-high frequencies the results are immediately comparable with the tolerances allowed by the FCC. The procedure in measurement is to plug in headphones,

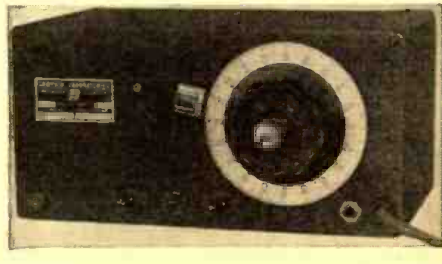

Micrometer Frequency Meter
● THE Type 103 Micrometer Frequency Meter, or MFM, is a band-spread, heterodyne-type, A.C. or D.C. operated instrument comprised of a

turn the dial for zero beat on the transmitter, and read the percentage deviation from the chart. The accuracy of the MFM must be maintained against standard-frequency transmissions from WWV, Bureau of Standards, Washington. Standardization must be done prior to measurements if

New Radio Apparatus

the meter is energized intermittently, or may be done periodically if energized continuously. It is not subject to obsolescence through changes in frequency assignments.

Frequency Range—The fundamental-frequency spread averages from 2300 to 2700 kc. A local transmitter or oscillator on any frequency up to 56 megacycles may be monitored. Received signals may be measured if they come within the fundamental range, or its harmonics.

Calibration—The standard calibration consists of a table giving dial readings for every 10-kc. fundamental frequency, and a ruler and scale for interpolating between the 10-kc. points to as close as 25 cycles. If operating frequencies are specified on order, a chart will be supplied at no extra cost reading in per cent deviation, for one to five fre-

quencies. A nominal charge is made for calibrations on additional channels. All charts are backed with aluminum and faced with celluloid, for protection in handling.

Controls—The frequency-control condenser consists of a cylindrical rotor, carried on the micrometer spindle in and out of an insulated stator. A 4-in. circular dial is coupled to the micrometer head by a spring, ball, and raceway. The dial has 200 divisions, a travel of 50 turns, and a total scale length of over 52 feet. The reading is taken directly from the Veeder counter and the dial scale. At the bottom of the panel are an R.F. coupling jack, a plate-voltage switch, a pilot light, a filament-voltage switch, and a jack for headphones. A trimmer screw is provided on the panel, for resetting the calibration.

Accuracy—The accuracy is guaranteed better than 0.01% when the calibration is maintained against WWV, a broadcast transmitter, or other source known to 0.001%. From WWV, standard frequencies may be heard anywhere in the U. S., many hours weekly, accurate to 0.00002%. A midget dual-wave broadcast receiver, or practically any type of short-wave receiver will pick up the transmissions on 5 mc., or on 10 or 20 mc. To check the MFM, the dial simply is set to a given point, and the panel trimmer adjusted for zero beat on the standard.

Tubes and Power Supply—A type 6J7 oscillator, a 6F5 detector, and a 6C5 rectifier are supplied with the instrument. Power supply is from a 115-volt line, A.C. or D.C., and the consumption is 35 watts.

NEW RADIO CATALOGS

New IRC Control Manual



- FULLY revised up to the last minute, listing almost one-third more replacements for radio receiver models than ever before, and giving complete control information at a glance, the new IRC Volume Control Replacement Manual is now available to members of the radio service profession.

Greatly enlarged in contents, the Manual contains 136 pages, including much helpful and detailed control information never before published in a handbook of this type. Utmost accuracy is assured by the fact that replacement control recommendations have been checked and double-checked against manufacturers' original drawings, revised specifications or latest engineering data. All needed information from manufacturers' original part numbers to Rider's Manual reference, price, resistance value, switch data, etc., is obtainable at a glance. All trade and brand names are listed alphabetically so that they can be quickly located. Auto radios are listed by make of car, rather than under the name of the actual manufacturer of the radios thus avoiding any danger of confusion. Chassis and model numbers of receivers are conveniently cross-indexed.

An interesting feature of the Manual is the fact that, except for the comparatively few necessary "specials", listings are based entirely on the use of Type D Controls with Tap-in Shafts. This feature not only simplifies the serviceman's work, but enables him to handle the big majority of all replacements from a small, inexpensive stock of controls.

In addition to much helpful information on the installation, use and construction of volume controls, the Manual includes complete control and resistor catalogs as well as a handy information section, charts and formulas.

American Radio Hardware Co.

- THE new catalog of the American Radio Hardware Co. contains a very interesting variety of tips, jacks and plugs as well as many different binding posts, test clips, and other devices of interest to radio set constructors. Among the useful tools we find small insulated screwdrivers, aligning tools, tuning wrenches, as well as soldering irons and different varieties of switches. Other material illustrated and described are various types of terminal boards, lamp sockets, dial lights, servicemen's tool kits, transmitting keys, brass and copper lugs, cable clamps, etc.

Salar Manufacturing Co.

- CATALOG NO. 11 lists and describes a very complete line of condensers of all types, including dry electrolytic, tubular dry types, wet electrolytic condensers, paper capacitors as well as condensers intended for television circuits, transmitting circuits, etc. Other condensers listed and

described cover auto radio requirements, industrial uses, radio noise-suppression, etc. One section deals with complete unit for radio noise-suppression; another part of the catalog describes trimming condensers of various types. Then we find descriptions of complete test instruments, mounted in cabinets, for use in checking resistance and capacity, etc.

Lafayette Radio

- THE new summer catalog No. 82 lists and describes in beautiful rotogravure the many different models of radio receivers supplied by this company, including every imaginable size and style of receiver, from large high-fidelity radio phonograph combinations, down to automobile receivers of the latest type. Other departments in this catalog cover a complete line of fixtures for the new fluorescent lighting; necessary supplies for radio experimenters—including batteries, tubes, tools, wire and cable; transformers of every description; resistors and potentiometers of all types; condensers of all the usual types; transformers for both transmitting and receiving purposes; transmitting coils and tuning condensers, etc. Complete transmitters as well as Communications receivers are described and illustrated. An excellent variety of radio and electrical books are listed in the catalog, as well as a surprising variety of test instruments—from "tube-testers," down to multi-purpose meters. Loudspeakers and parts of interest to radio repair men are described and illustrated in great detail.

A very attractive line of public-address amplifiers and loudspeakers, together with microphones, are illustrated and described in elaborate fashion.

BOOK REVIEWS

CYCLOPEDIA OF TELEVISION FACTS compiled by M. N. Beitman. This new handbook of television facts, published by Supreme Publications, Chicago, will be useful to every student of television and radio. It is specially written in elementary fashion and cleverly illustrated with simplified pictures and diagrams, so that the average student can quickly grasp the fundamental principles of television.

The subjects covered in the book are listed alphabetically so that quick reference may be made to them. A complete diagram of a typical "sight and sound" receiver is given, so that the more ambitious students of the subject can see just what goes into a complete television receiver. Among the subjects illustrated and described there are—the cathode-ray tube; deflecting coils;

dipoles; electron lens; the eye; electron emission; fluorescent screen; iconoscope; kinescopes; light theory; photo cell; secondary emission, and synchronization.

"HANDBOOK" AVAILABLE IN SPANISH

- THE fourth annual Spanish edition of the American Radio Relay League's "Radio Amateur's Handbook," made its appearance recently.

Designed for use by the thousands of licensed amateur operators and short-wave engineers of the Latin American republics, the 530-page Spanish version of the manual is produced by the editors and publishers of "Revista Telegrafica," one of the oldest radio magazines in the world, under an agreement with the League negotiated in 1937. The Spanish staff, located in Buenos Aires. Ar-

gentina, consists of men highly skilled in languages as well as the complicated science of radio, insuring the accuracy and authoritativeness of the text.

INTO UNSEEN WORLDS—the RCA Electron Microscope. This very handsome book bound in artistic paper covers printed in colors, describes the new electron microscope perfected by the RCA Laboratories, and shows—with startling pictures—the high-power magnifications that are made possible with it. Some of the plates show for example tuberculosis germs magnified 24,000 diameters; a section of calcium carbonate magnified 60,000 diameters, and a particle of magnesium oxide magnified 70,000 diameters! The entire useful magnification which can be obtained with the total enlargement is between 60,000 and 120,000 diameters, according to a statement made in this book.

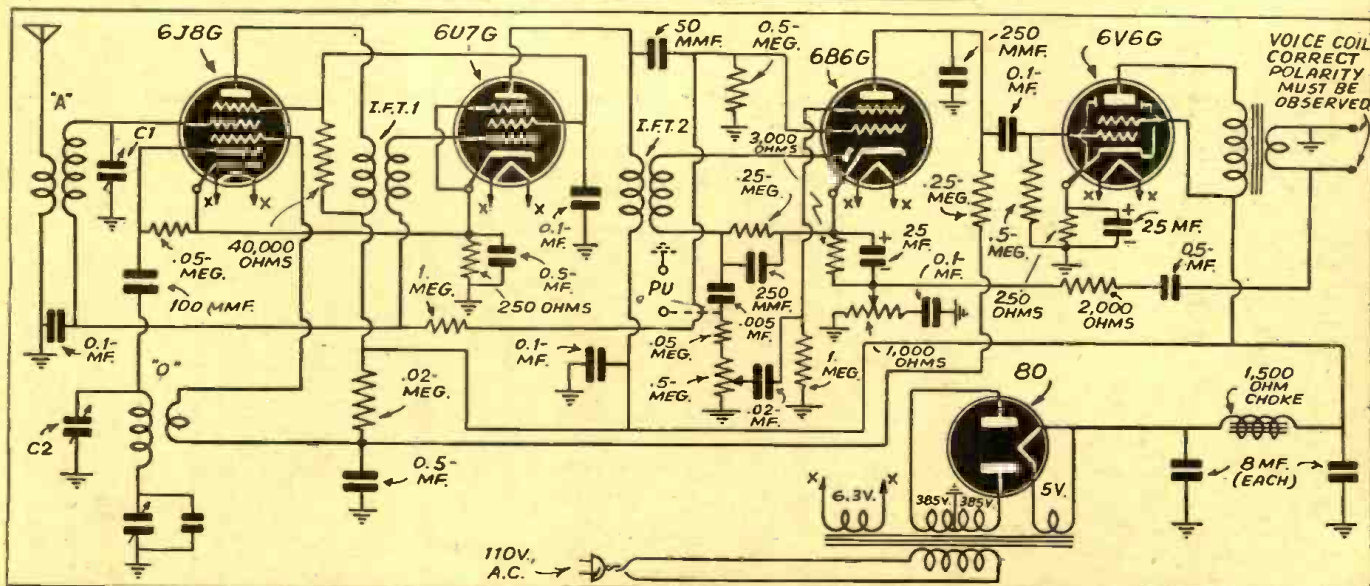

CORRECTION NOTICE: This diagram should have appeared with the text on page 203 of the August issue. Refer to it for construction details.

Readers' Editorials

(Continued from page 261)

as they are made. The substantiation of claims for design in the form of accurate checks on frequency range, percentage of distortion and power output of audio frequency equipment has been particularly valuable. The results of research thus far justify the conviction that significant progress is being and will continue to be made toward the attainment of true fidelity in the reproduction of sound and music. A considerable number of musicians and amateur music lovers watch that progress with approving interest.

WAYNE BARLOW,
170 Elmcroft Road,
Rochester, N. Y.

WHY CHANGE THE EXAM?

● THERE has been some talk going on concerning revision of amateur licensing and privileges. Ever since the government has required operator and station licenses, a fine bunch of well informed Hams, for the most part, have been turned out. Yes, they probably did use the "Study Guide" to aid them in their exams; they needed some form of guide to have an idea of what the exam is all about. The new multiple-choice type of examination requires the applicant to have quite a thorough knowledge of radio theory, law and practice.

Suggestions have been made resolving that ultra-high frequency operation could be had by anyone who desired (or until the person was skilled enough to obtain his license)—well, isn't that going a little too far? Imagine a bunch of *really uninformed* operators crowding those bands, which are continually becoming more popular and useful! Possibly the greater number of that gang would be so taken up with UHF operation, that the other Ham hands would be of little interest to them. All this means *not trained radio amateurs* but a bunch of *nitwits*, who regard amateur radio communication as a mere plaything.

In the future we can, and will, turn out a group of amateur radio operators as fine as those of the past, without the necessity of experimenting with a new type of licensing system.

FRANCIS STERK,
398 Osceola Road,
Calumet, Michigan.

AN ARMY NECESSITY

● SUMMARIZING my thoughts in behalf of the many young men who in the future shall serve their country's call to duty, I hope to emphasize to those who possess the ambitious, persistent, and sincere minds, to learn a vocation which would benefit both himself and his country as a whole. To those minds of sincerity, I extend my hand to welcome their thoughts and reasons on no other subject than the vital and growing vocation of radio.

In the swift, striking, moving war of today, where mechanism moves with terrific speed and precise accuracy, the vital and total success of it depends largely on *communication*, not with entangling wires whose secrecy would be doubted, but by air,

FREE CATALOGS and INFORMATION

By carefully reading the advertising columns, you will find many offers to furnish literature containing valuable technical information that will help you in your work. Use this list freely.

Firm	Business	Offer	No.	Cost	Adv. Page
ABC Radio Laboratories Aerovox Corporation	Set Mfr.	Information		Free	297
	Parts Mfr.	1941 Catalog		Free	273
		Research Worker		Free	
Allied Engineering Institute Allied Radio Corp.	Kit Mfr.	Circulars		Free	280
	Mail Order	1942 Radio Catalog		Free	271, 285
		Builder's Handbook		10c	
		Radio Dictionary		10c	
American Radio Institute Ayers Automatic Code Machines	Radio School	Booklet		Free	284
	Code Machines	Information		Free	291
Bliley Electric Co.	Parts Mfr.	Circular	D-2	Free	287
		Engineering Bulletin	E-6	10c	
		Bulletin	E-7	Free	
		Circular	A-7	Free	
		Literature		Free	I.B.C.
		Catalog	241	Free	295
		1941 Catalog	57	Free	300
Brush Development Co. Bud Radio, Inc.	Parts Mfr.	1941 Catalog		Free	300
	Parts Mfr.	Book of Facts		Free	290
Burstein-Applebee Co.	Mail Order	Folder	T-27	Free	291
Candler System Co.	Code Course	Booklet		Free	309
Cannon, C. F., Co.	Parts Mfr.				
Chartered Institute of American Inventors	Inventors				
	Organization				
Commercial Radio Institute Dodge's Institute	Radio School	32-Page Catalog		Free	290
	Radio School	Catalog		Free	259
Evans, Victor J., & Co.	Patent Attorneys	Books		Free	309
Gold Shield Products	Mail Order	Catalog		Free	287, 295, 310
Hallicrafters, Inc. Hammarlund Mfg. Co.	Set Mfr.	Literature		Free	B.C.
	Set & Parts Mfr.	Short Wave Manual		10c	281
Harrison Radio Co.	Mail Order	Information—List		Free	290
Henry Radio Shop	Mail Order	Information		Free	284
Hudson Specialties Co.	Mail Order	1941 Catalog		Free	307
Instructograph Company	Code Machine	Information		Free	290
International Resistance Co.	Parts Mfr.	Information		Free	279
Lancaster, Allwine & Rommel	Patent Attorneys	Booklet		Free	309
Laughlin Mfg. Co.	Pen Mfr.	Information		Free	293
Mass. Radio School	Radio School	60-Page Catalog		Free	259
Michigan Radio Products	Set Mfr.	Information		Free	295
Midget Radio Co.	Set Mfr.	Information		Free	297
Midwest Radio Corp.	Set Mfr.	1942 Catalog		Free	297
Millen, J., Mfg. Co., Inc.	Parts Mfr.	Catalog		Free	284
National Broadcasting Co.	Broadcasting	Information		Free	I.F.C.
National Company, Inc.	Set & Parts Mfr.	Catalog		Free	283
National Radio Institute	Radio School	64-Page Book		Free	257
National Schools	Radio School	Catalog		Free	259
Nelson Co.	Used Courses	72-Page Catalog		Free	310
N.Y. Institute of Photography	Photo. School	Booklet		Free	296
New York Y.M.C.A. Schools	Trade School	Book		Free	259
Radio & Technical Publ. Co.	Radio Textbooks	Circulars on each book		Free	291
RCA Institutes, Inc.	Radio School	Catalog		Free	284
Remington Rand, Inc.	Typewriter Mfr.	Catalog		Free	311
Sprayberry Acad. of Radio	Radio School	52-Page Book		Free	259
Teleplex Co.	Code Machines	Catalog	S-9	Free	287
Triplett Electrical Inst. Co.	Parts Mfr.	Catalog		Free	287
Tri-State College	Radio School	Catalog		Free	297
X. L. Radio Laboratories	Parts Mfr.	Information		Free	295

the free medium to carry significant messages to its moving columns. We, of today, cannot help but be optimistic in combating weapons of terrifying and deadly devices, continually subjected upon civilization.

As the news of today reaches us, we question how such cooperation can be maintained. But with the achievement of compact, light *short-wave* (and ultra short-wave) equipment, now in use throughout

Index to Advertisers

A	
ABC Radio Laboratories.....	297
Aerovox Corporation.....	273
Allied Engineering Institute.....	280
Allied Radio Corporation.....	271, 285
American Radio Institute.....	284
Ayers Automatic Code Machines.....	291
B	
Barter & Exchange Ads.....	317
Bliley Electric Co.....	287
Brush Development Co., The.....	Inside Back Cover
Bud Radio, Inc.....	295
Burstein-Applebee Co.....	300
C	
Candler System Co.....	290
Cannon, C. F., Co.....	291
Chartered Institute of American Inventors.....	309
Commercial Notices.....	317
Commercial Radio Institute.....	290
D	
Dataprint Company.....	309, 310
Dodge's Institute.....	259
E	
Evans, Victor J., & Co.....	309
F	
Flight Magazine.....	300
For Sale Ads.....	317
G	
Gold Shield Products.....	287, 295, 310
H	
Hallcrafters, Inc.....	Back Cover
Hammarlund Manufacturing Co., Inc.....	281
Harrison Radio Co.....	290
Henry Radio Shop.....	284
Hudson Specialties Company.....	307
I	
Instructograph Company.....	290
International Resistance Co.....	279
L	
Lancaster, Allwine & Rommel.....	309
Laughlin Mfg. Company.....	293
M	
Mass. Radio School.....	259
Michigan Radio Products.....	295
Midget Radio Co.....	297
Midwest Radio Corp.....	297
Millen, James, Mfg. Co., Inc.....	284
N	
National Broadcasting Company.....	Inside Front Cover
National Company, Inc.....	283
National Plans Institute.....	287
National Radio Institute.....	257
National Schools.....	259
Nelson Co.....	310
N. Y. Institute of Photography.....	296
New York Y.M.C.A. Schools.....	259
R	
Radio Amateur Course.....	293
Radio & Technical Publ. Co.....	291
Radio Publications.....	300, 303, 305, 315
Radio-Television Reference Annual.....	316
RCA Institutes, Inc.....	284
Remington Rand, Inc.....	311
S	
Sprayberry Academy of Radio.....	259
T	
Technifax.....	287, 301
Teleplex Co.....	287
Triplet Electrical Instrument Co.....	287
Tri-State College.....	297
X	
X.L. Radio Laboratories.....	295

(While every precaution is taken to insure accuracy, we cannot guarantee against the possibility of an occasional change or omission in the preparation of this index.)

the modernistic armies of today, this has been accomplished.

Here, in the United States, our younger generation has easily available many simple and technical radio books and apparatus which can be obtained cheaply. In our public libraries, valuable books are constantly in demand, filled with priceless data for developing and guiding the minds of our defense youth.

America has many productive minds which must and shall be developed, if our way of living is to be improved and our national security maintained.

LADISLAW MACH,
4603 Harrison Street,
So. Omaha, Nebraska.

THIS LICENSE PROBLEM

SO much has been said about how difficult it is to learn the code and radio theory in order to obtain an Amateur Radio Operator's License, that many "would-be" hams are too scared to even try!

Of course it's hard work, but everything that is worth doing at all is worth doing well! It is really only hard if we think it is. If we love it, if it gives us the wonderful pleasure that radio experimentation does, it is a glorious adventure!

Many of us are now being called into the military service of our country. To you, and to those who are serving their country at home, I say: "Let us plunge into the joyful task of getting our ticket with unbounded enthusiasm, and we will not only be serving our country, but we will also be enriching our own lives, by our devotion to this science which merits the best we can give!"

VERLYN HEIN,
Hortonville, Wisc.

ONE OF THE STEPPING STONES OF PROGRESS

WHEN the radio designer, builder, or experimenter in his own workshop constructs a new gadget, it is very simple to him and to those who know something of its underlying principles, but to the vast crowd of people outside his own "laboratory" it is a great work of ingenuity and mystery. From the many boxes of "junk" in the radio experimenter's sanctorum, combined with his curiosity, comes the avalanches of modernization and progress in the world of radio.



Prize set awarded for best "Reader's" Editorial this month—the ADMIRAL 79-P6 3-way portable. This handsome portable receiver operates on its own battery, or it may be plugged into any 110 Volt A.C. or D.C. current outlet. It is a 6-tube receiver and has a tuned R.F. stage to boost weak signals. A special built-in aerial is fitted into the cabinet. The receiver covers the broad-cast band, 540 to 1630 kilocycles. The case is a handsome one and measures 13 1/4" wide, 10" high, 6 1/2" deep.

The first stone began to roll when Marconi put his curiosity to work on the mysterious Hertzian waves. It was he who sent the first message of communication without the use of wires. From then on, other men have taken an interest in this newfound step towards greater civilization.

Today, as in the time of Marconi, more stones are rolling in this avalanche of modern progress. These stones of television, facsimile recording, and frequency modulation are moving to the front.

It was radio that brought us out of the "dark ages" and into the light of the century. Radio and its associated companions may be well spoken of as the life-line of the world. The advancement of the known facts and theories of radio should be encouraged and well-used in every part of the world. Radio is only in its beginning and already it is widely used in communication, science, and medicine. In the years to come, this modern invention, with the help and cooperation of the people of the world, will bring forth a new era of civilization.

WAYNE FURNELL,
529 E. 12th Street,
Bartlesville, Okla.

ANSWERS TO PUZZLE DIAGRAM ON PAGE 300

- In diagram "A" of the condenser mike hook-up, the 50 ohm resistor should be 25-50 megohms, the 1,000 ohm resistor should be about 10 megohms. 200 volts B plus should be applied to the condenser mike instead of 6 volts. The 1,000 ohm resistor in the amplifier plate circuit should be 100,000 ohms and the 100 ohm resistor should be about 10,000 ohms.
- In the hook-up of the double-button mike at "B," four to six volts should be applied instead of 200 volts. Also the central member of the mike should be connected to the center tap terminal on the primary of the coupling transformer.
- With the dynamic mike hook-up at "C," no battery or other source of current is necessary in the mike circuit.
- In diagram "D" for the ribbon mike hook-up, no battery or other source of current is needed as it develops its own EMF.
- In diagram "E," showing hook-up of crystal mike, no battery is needed as the mike develops its own voltage.

BRUSH

Crystal

PRODUCTS

*Meet
Exacting
Requirements*

BRUSH CRYSTAL HEADPHONES TYPE "A"

The recognized standard for high quality wide range response, dependable, non-magnetic, lightweight yet durable . . . easy and comfortable to wear. Available in double, single and Lorgnette styles.

BRUSH CRYSTAL RECORD CUTTER RC-20

Suitable for all amateur and professional applications with either hard or soft record materials. Will satisfy the demand for high quality, low cost recording in the home, school and studio.

BRUSH CRYSTAL PHONOGRAPH PICKUPS, PL-20 AND PL-25

For all high fidelity phonograph and transcription applications. Permanent, polished sapphire stylus, virtually no record wear, minimum surface noise. The PL-20 is designed for records and turntables up to 16" in diameter, and the PL-25 for records and turntables up to 12" in diameter.

BRUSH CRYSTAL SOUNDCELL ALL PURPOSE MICROPHONE, TYPE BR25

Ideal for radio broadcasting, sound pictures, and general sound recording, public address, and other applications where wide range response is of paramount importance.

BRUSH
—CRYSTAL—
PRODUCTS

THE BRUSH DEVELOPMENT CO.
3316 PERKINS AVENUE • • • CLEVELAND, OHIO

www.americanradiohistory.com

An Advanced Communications Design

THE Skyrider 32

The new Skyrider 32 for 1942 embodies many noteworthy engineering advancements in the communications field. Covers everything on the air, from 500 kc. to 40 mc. Thirteen tubes. Six bands. Two stages preselection on four highest frequency bands. Calibrated bandspread inertia controlled. Micrometer scale tuning inertia controlled. AF gain — RF gain. Crystal phasing. Adjustable noise limiter. Send-receive switch — AVC-BFO switch. 80/40/20/10 meter amateur bands calibrated. Wide angle "S" meter. Push-pull high fidelity audio output. 6-step wide range variable selectivity.

The new Skyrider 32 has been engineered by Hallicrafters to produce superior communications receiver performance at a moderate price.

Ask your Hallicrafters Distributor for full details.

the hallicrafters co.

CHICAGO, U. S. A.



USED BY

33 GOVERNMENTS

SOLD IN 49 COUNTRIES